

ISO SCALE 2 : 1

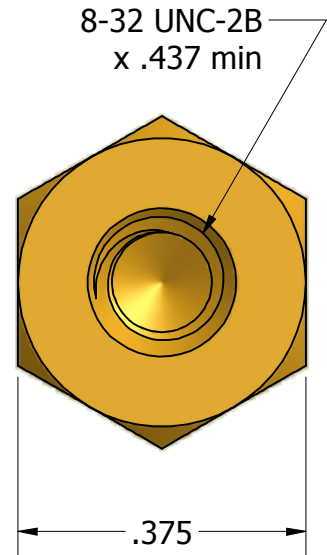
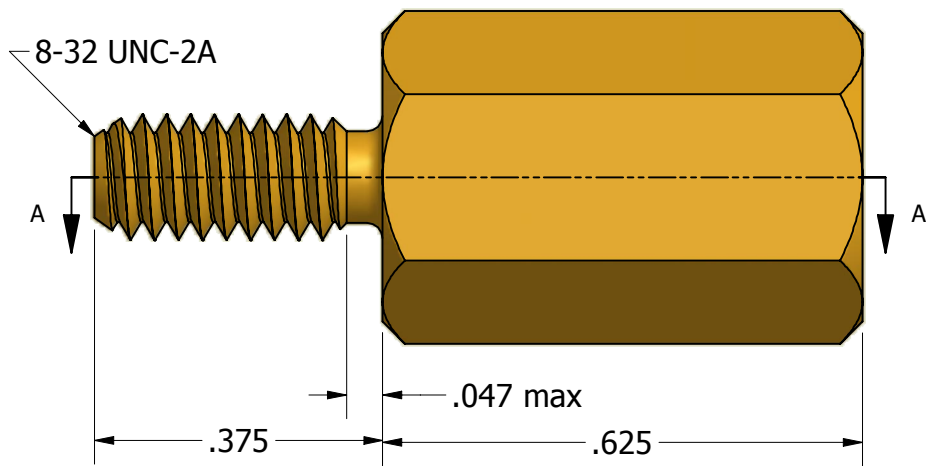

Finish:
Spec:
Type:
Class:

Tolerances Unless Otherwise Specified:		LYN-TRON, INC.	
.xx Decimal: ± .02			
.xxx Decimal: ± .005		Part Number:	
Fraction: ± 1/64		NAS1829BT6G10	
Angle: ± 2°		Description:	
		3/8" HEX MALE FEMALE STANDOFF	
Drawn By:	Gauge:	Material:	Scale:
COURTNEYS09/11/2012	PP	Brass 360 (11)	4 : 1