

ISO SCALE 2 : 1

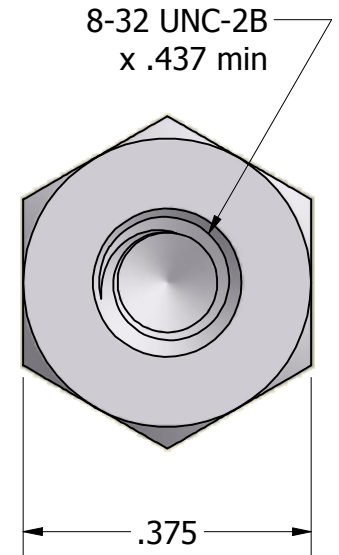
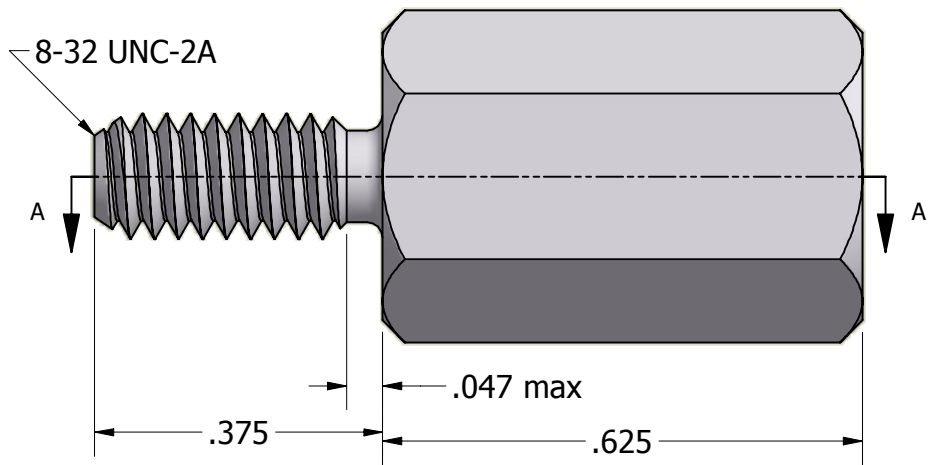

Finish:
Spec:
Type:
Class:

Tolerances Unless Otherwise Specified:
 .xx Decimal: ± .02
 .xxx Decimal: ± .005
 Fraction: ± 1/64
 Angle: ± 2°

LYN-TRON, INC.

Part Number:
NAS1829A6H10

Description:
3/8" HEX MALE FEMALE STANDOFF

Drawn By:
COURTNEYS09/06/2012

Gauge:
STD

Material:
Aluminum 2024-T4 (T6)

Scale:
4 : 1