

ISO SCALE 1 : 1

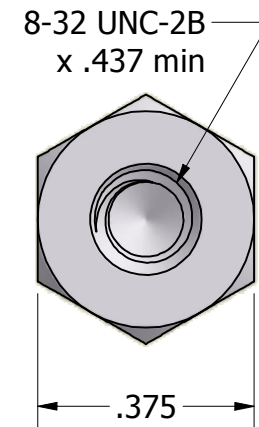
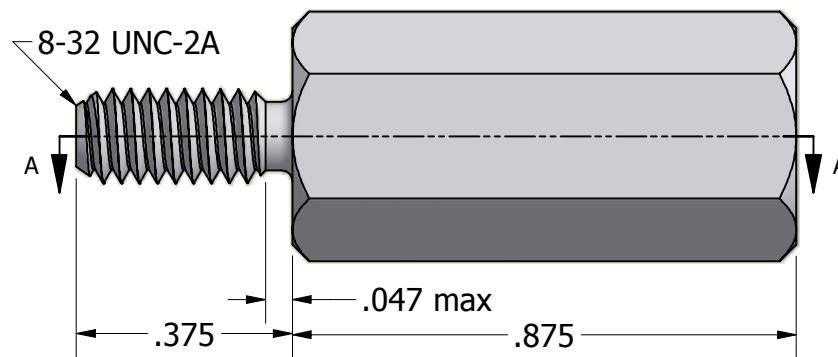

Finish:
Spec:
Type:
Class:

Tolerances Unless Otherwise Specified:

.xx Decimal: ± .02
.xxx Decimal: ± .005
Fraction: ± 1/64
Angle: ± 2°

LYN-TRON, INC.

Part Number:

NAS1829A6G14

Description:

3/8" HEX MALE FEMALE STANDOFF

Drawn By:

COURTNEYS09/06/2012

Gauge:

STD

Material:

Aluminum 2024-T4 (T6)

Scale:

3 : 1