

ISO SCALE 2 : 1

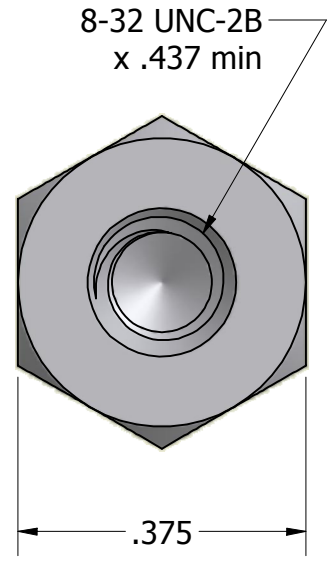
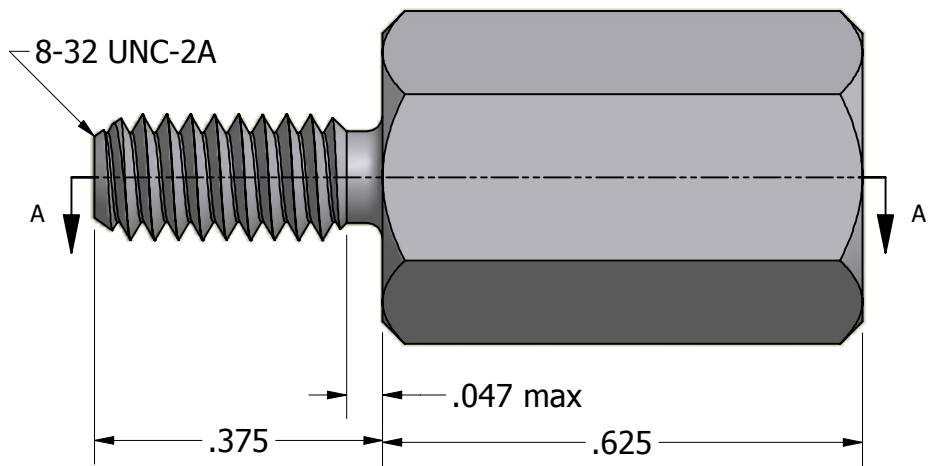

Finish:  
Spec:  
Type:  
Class:

Tolerances Unless Otherwise Specified:		<b>LYN-TRON, INC.</b>	
.xx Decimal: ± .02			
.xxx Decimal: ± .005		Part Number:	
Fraction: ± 1/64		<b>NAS1829-6G10</b>	
Angle: ± 2°		Description:	
		<b>3/8" HEX MALE FEMALE STANDOFF</b>	
Drawn By:	Gauge:	Material:	Scale:
<b>COURTNEYS08/30/2012</b>	<b>STD</b>	<b>Steel</b>	<b>4 : 1</b>