

ISO SCALE 2 : 1

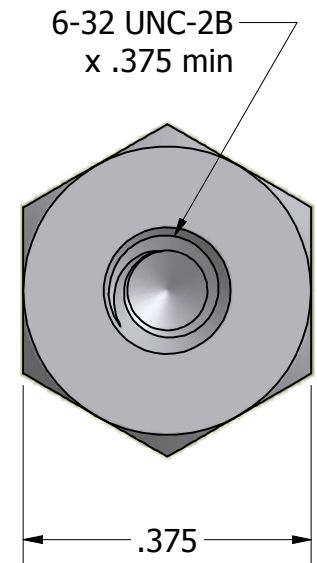
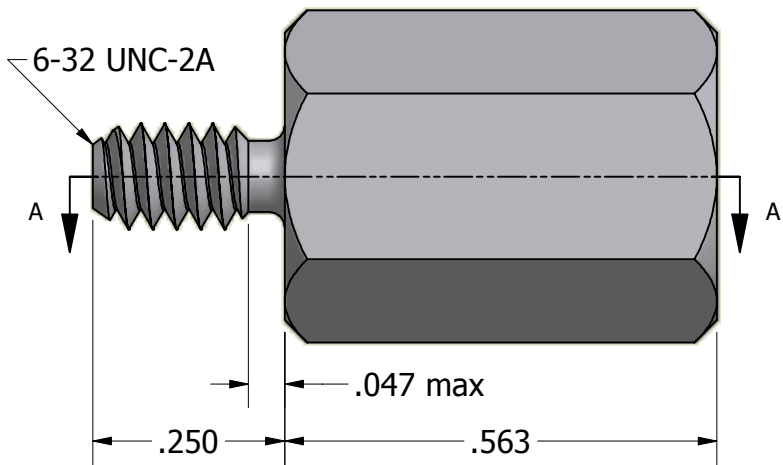

Finish:
Spec:
Type:
Class:

Tolerances Unless Otherwise Specified:
 .xx Decimal: $\pm .02$
 .xxx Decimal: $\pm .005$
 Fraction: $\pm 1/64$
 Angle: $\pm 2^\circ$

LYN-TRON, INC.			
Part Number: NAS1829-6E09			
Description: 3/8" HEX MALE FEMALE STANDOFF			
Drawn By: COURTNEYS08/30/2012	Gauge: STD	Material: Steel	Scale: 4 : 1