

SECTION A-A

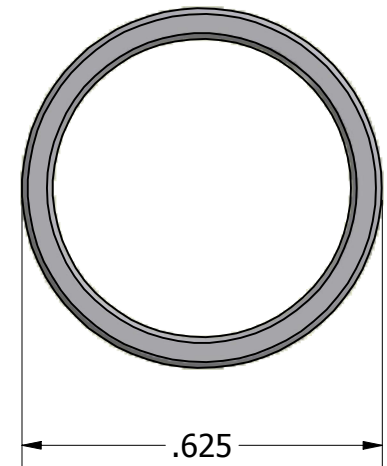

ISO SCALE 1 : 1

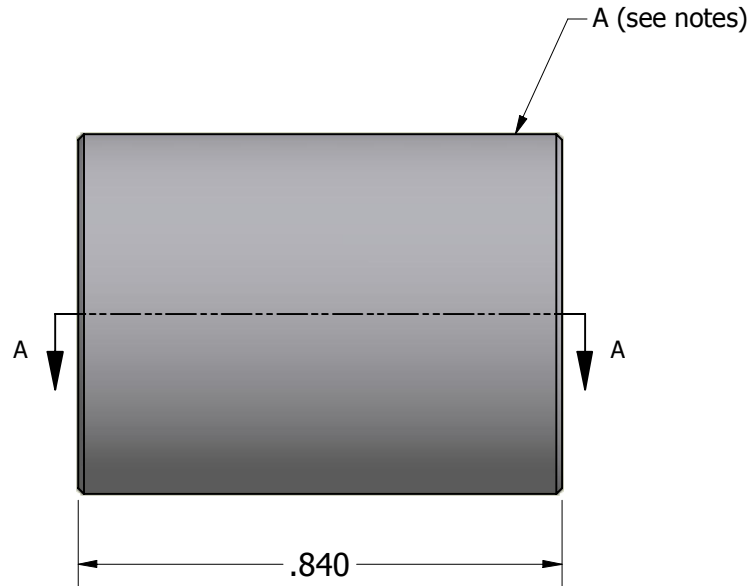

Notes:

A- Mark with recessed letter to indicate material in accordance with material code letters. All items .094 or less in length may be identified by tagging the material code letter on 10% of any shipment.

Finish: Passivate

Tolerances Unless Otherwise Specified:

.xx Decimal: ± .02
.xxx Decimal: ± .005
Fraction: ± 1/64
Angle: ± 2°

LYN-TRON, INC.

Part Number:

NAS1057T8-084

Description:

5/8" ROUND SPACER (STAINLESS STEEL)

Drawn By:

RICKZ

01/12/2012

Gauge:

STD

Material:

Stainless Steel (303)

Scale:

3 : 1