

SECTION A-A

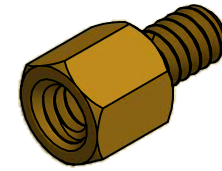

ISO SCALE 3 : 1

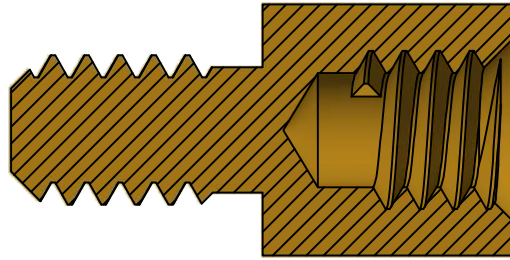
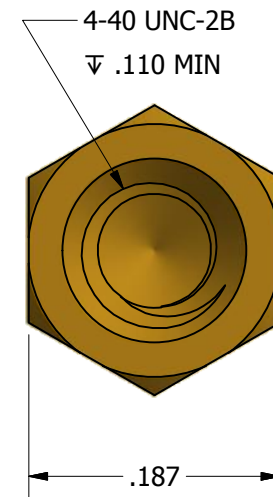
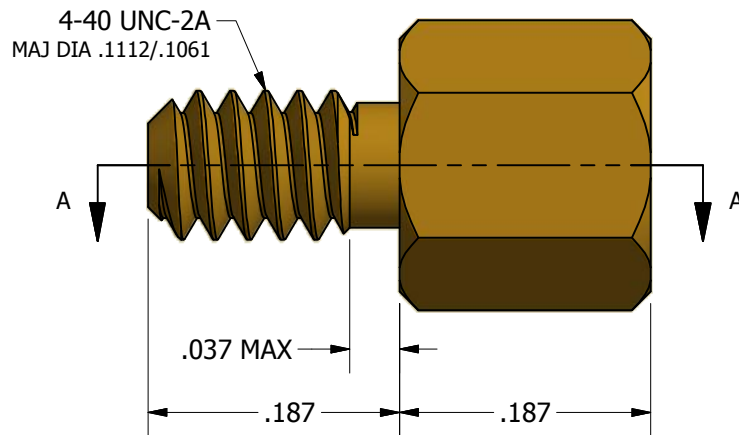

Notes:

Tolerances Unless Otherwise Specified:

.xx Decimal: $\pm .01$
 .xxx Decimal: $\pm .004$
 Fraction: $\pm 1/64$
 Angle: $\pm 2^\circ$

Notes Unless Otherwise Specified:

- (1) Break Sharp Edges
- (2) Remove All Burrs

LYN-TRON, INC.

P/N:

BR9410

Description:

3/16 Hex Jack Screw

Drawn By:

Rick Z

Date Created:

08/22/2018

Gauge:

Material:

Brass

Linked Part:

Scale:

7:1