

SECTION A-A

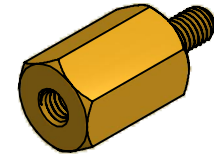

ISO SCALE 1 : 1

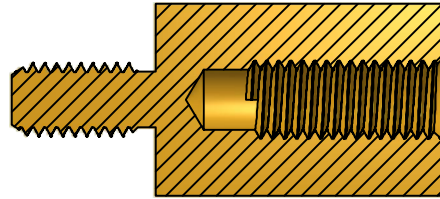
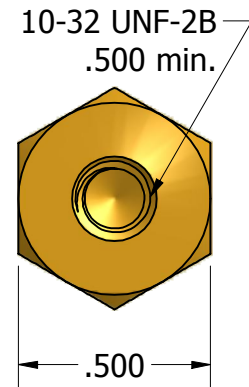
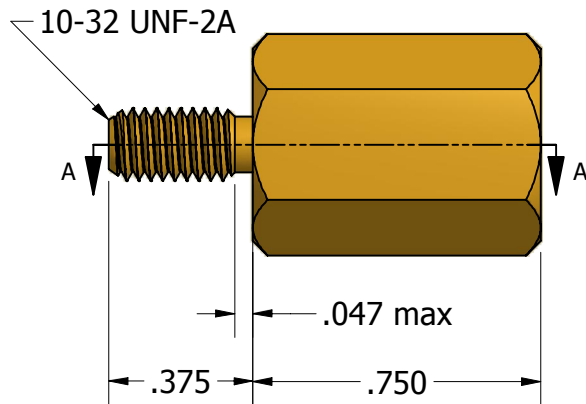

Tolerances Unless Otherwise Specified:

.xx Decimal: ± .02
.xxx Decimal: ± .005
Fraction: ± 1/64
Angle: ± 2°

LYN-TRON, INC.

Part Number:

BR6987-0.750

Description:

1/2 Hex Male-Female Standoff

Drawn By:

KENANG 06/25/2011

Gauge:

Material:

Brass

Scale:

2 : 1