

SECTION A-A

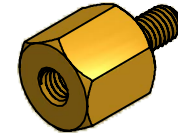

ISO SCALE 1 : 1

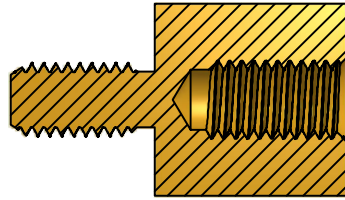
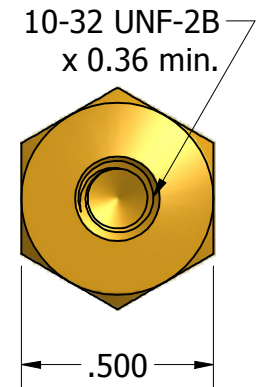
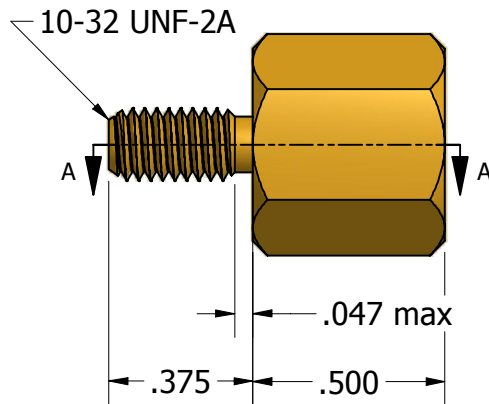

Tolerances Unless Otherwise Specified:			
<b>.xx Decimal:</b> ± .02 <b>.xxx Decimal:</b> ± .005 <b>Fraction:</b> ± 1/64 <b>Angle:</b> ± 2°			
Part Number: <b>BR6987-0.500</b>		Description: <b>1/2 Hex Male-Female Standoff</b>	
Drawn By: <b>KENANG 06/25/2011</b>	Gauge:	Material: <b>Brass</b>	Scale: <b>2 : 1</b>