

SECTION A-A

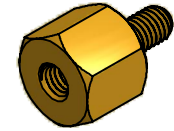

ISO SCALE 1 : 1

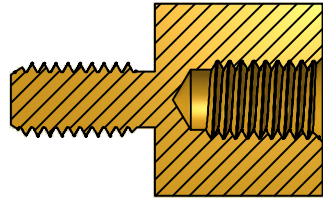
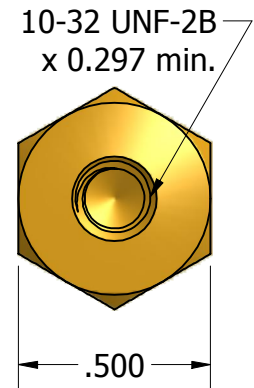
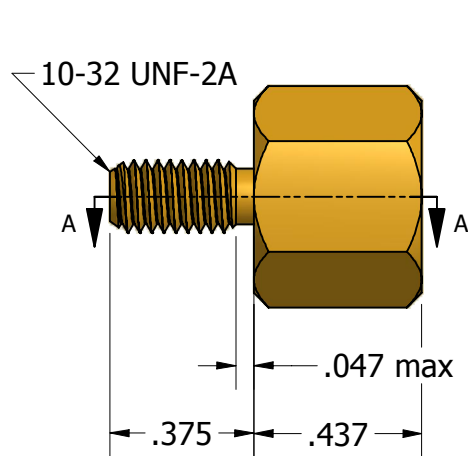

Tolerances Unless Otherwise Specified:

**.xx Decimal:** ± .02  
**.xxx Decimal:** ± .005  
**Fraction:** ± 1/64  
**Angle:** ± 2°

**LYN-TRON, INC.**

Part Number:

**BR6987-0.437**

Description:

**1/2 Hex Male-Female Standoff**

Drawn By:

**KENANG 06/25/2011**

Gauge:

Material:

**Brass**

Scale:

**2 : 1**