

SECTION A-A

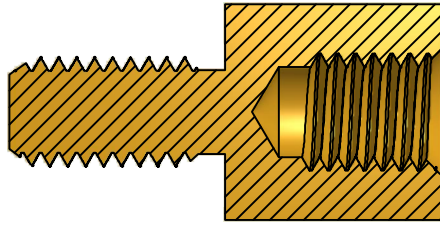

ISO SCALE 1 : 1

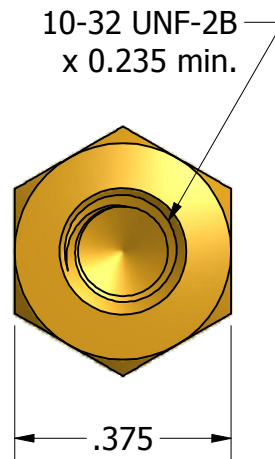
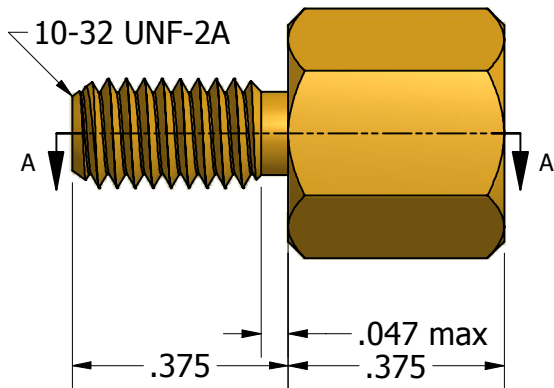

Tolerances Unless Otherwise Specified:

.xx Decimal: $\pm .02$
.xxx Decimal: $\pm .005$
Fraction: $\pm 1/64$
Angle: $\pm 2^\circ$

LYN-TRON, INC.

Part Number:

BR6986-0.375

Description:

3/8 Hex Male-Female Standoff

Drawn By:

KENANG 06/25/2011

Gauge:

Material:

Brass

Scale:

3 : 1