

SECTION A-A

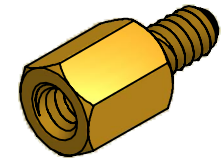

ISO SCALE 2 : 1

6-32 UNC-2B
x 0.198 min.

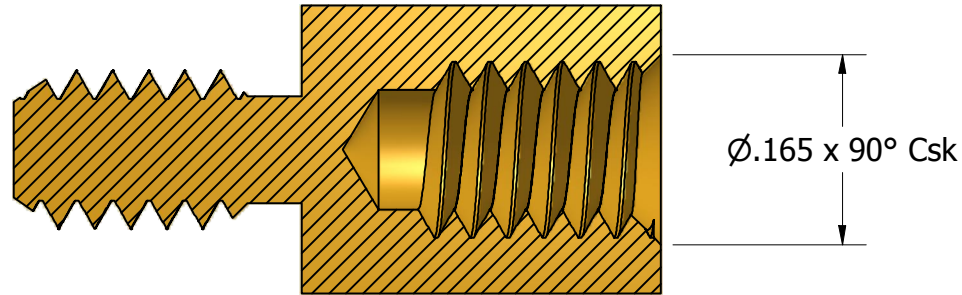
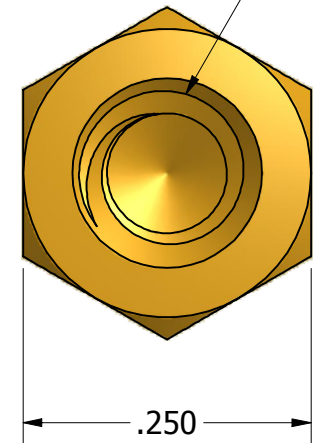
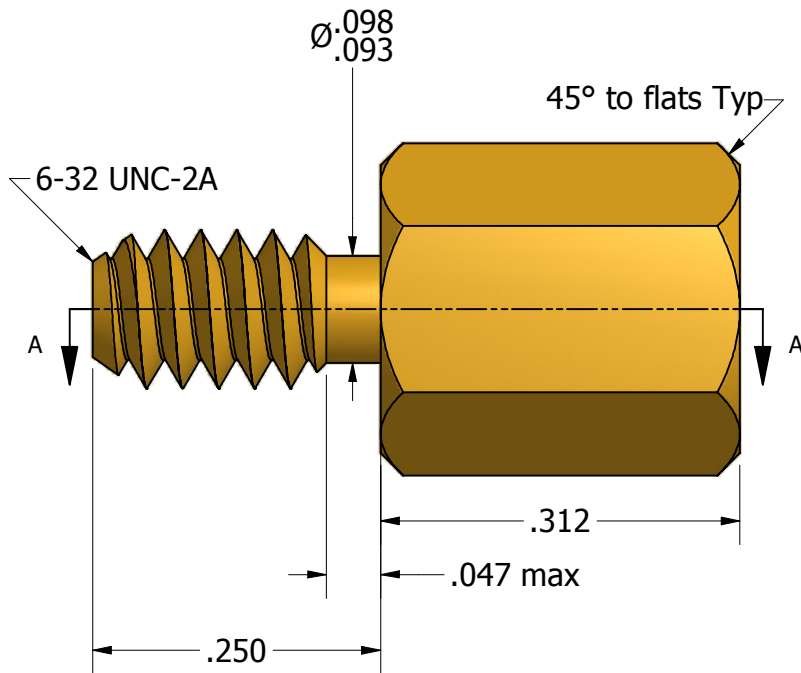

Tolerances Unless Otherwise Specified:

.xx Decimal: ± .02
.xxx Decimal: ± .005
Fraction: ± 1/64
Angle: ± 2°

LYN-TRON, INC.

Part Number:

BR6981-0.312

Description:

1/4 Hex Male-Female Standoff

Drawn By:

KENANG 06/25/2011

Gauge:

Material:

Brass

Scale:

6 : 1