

SECTION A-A

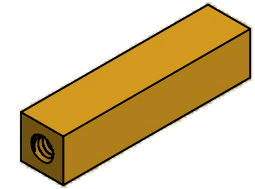

ISO SCALE 1 : 1

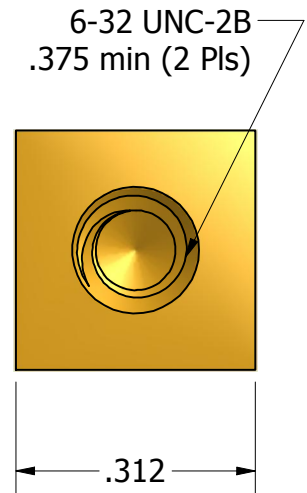
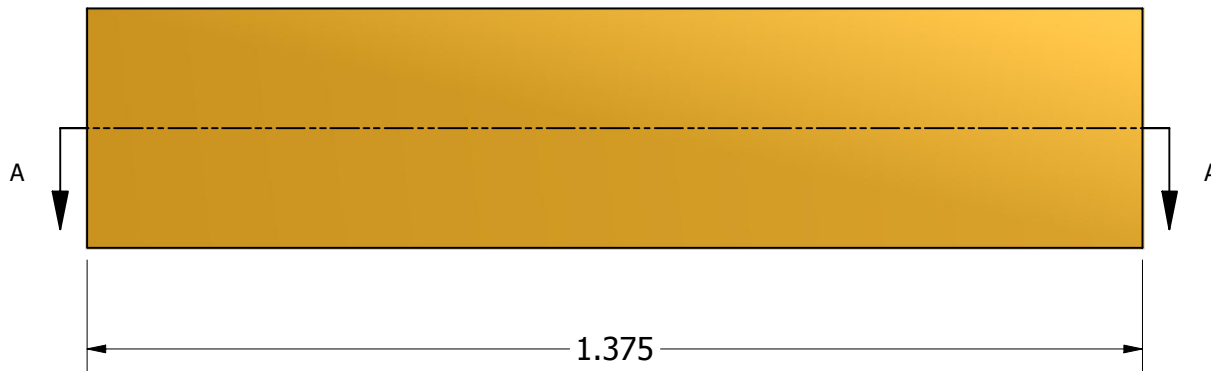

Tolerances Unless Otherwise Specified:

.xx Decimal: ± .02
.xxx Decimal: ± .005
Fraction: ± 1/64
Angle: ± 2°

LYN-TRON, INC.

Part Number:
BR6962-0632-1.375

Description:
5/16 Square Standoff

Drawn By:
COURTNEYS09/10/2011

Gauge:

Material:
Brass

Scale:
4 : 1