

SECTION A-A

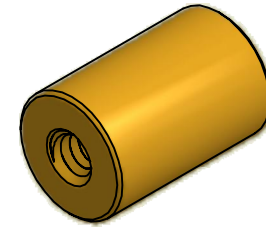

ISO SCALE 2 : 1

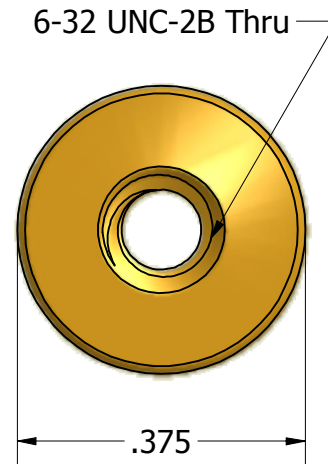
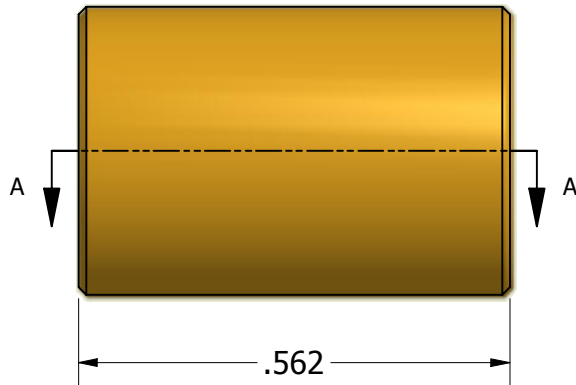

Tolerances Unless Otherwise Specified:

.xx Decimal: $\pm .02$
.xxx Decimal: $\pm .005$
Fraction: $\pm 1/64$
Angle: $\pm 2^\circ$

LYN-TRON, INC.

Part Number:
BR6943-0632-0.562

Description:
3/8 Round Standoff

Drawn By:
JEFFN 07/15/2010

Gauge:

Material:
Brass

Scale:
4 : 1