

SECTION A-A

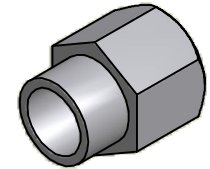

ISO SCALE 4 : 1

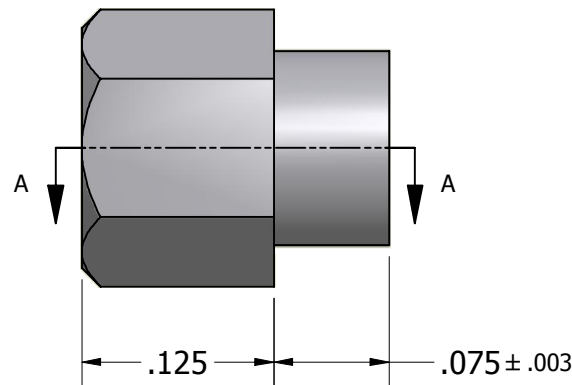

2-56 UNC-2B Thru

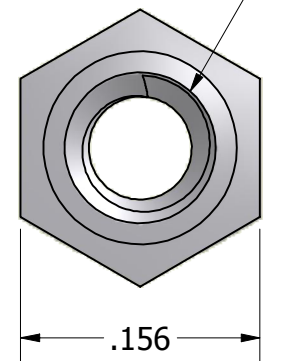

Tolerances Unless Otherwise Specified:

.xx Decimal: $\pm .02$
.xxx Decimal: $\pm .005$
Fraction: $\pm 1/64$
Angle: $\pm 2^\circ$

LYN-TRON, INC.

Part Number:

BR6929A-0.125

Description:

5/32 Hex Swage Standoff

Drawn By:

JEFFN

06/22/2010

Gauge:

Material:

Brass

Scale:

8 : 1