

SECTION A-A

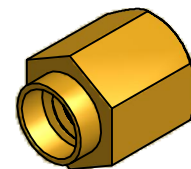

ISO SCALE 2 : 1

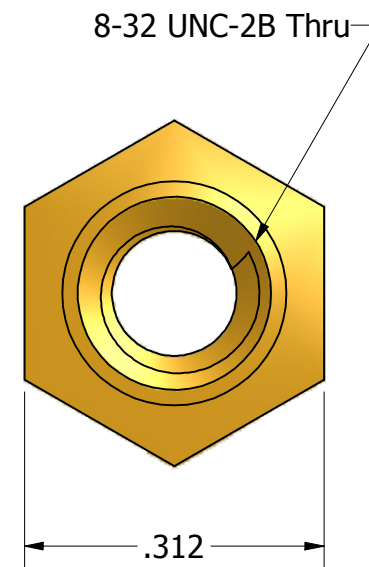
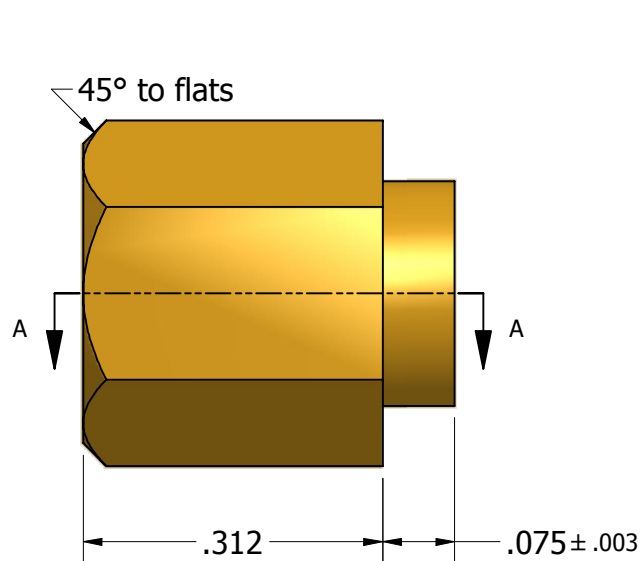

Tolerances Unless Otherwise Specified:

.xx Decimal: ± .02
 .xxx Decimal: ± .005
 Fraction: ± 1/64
 Angle: ± 2°

LYN-TRON, INC.

Part Number:

BR6923A-0.312

Description:

5/16 Hex Swage Standoff

Drawn By:

JEFFN

06/22/2010

Gauge:

Material:

Brass

Scale:

5 : 1