

SECTION A-A

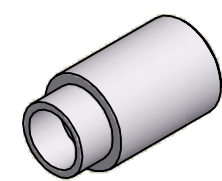

ISO SCALE 3 : 1

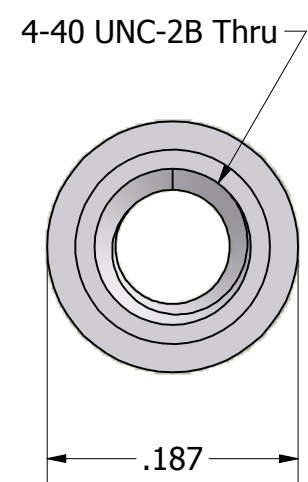
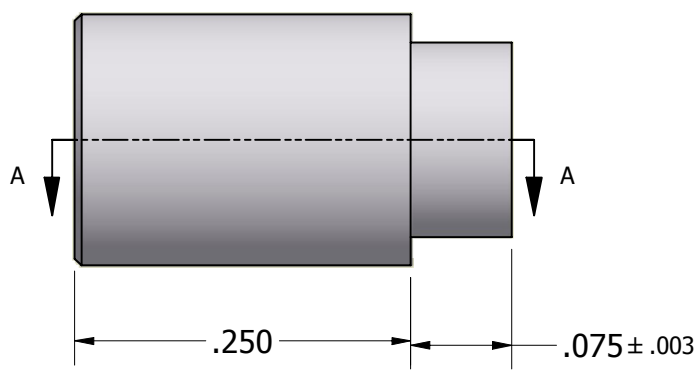

Tolerances Unless Otherwise Specified:

- .xx Decimal:** ± .02
- .xxx Decimal:** ± .005
- Fraction:** ± 1/64
- Angle:** ± 2°

LYN-TRON, INC.

Part Number:
BR6915A-0.250

Description:
3/16 Round Swage Standoff

Drawn By:
JEFFN 06/22/2010

Gauge:

Material:
Brass

Scale:
7 : 1