

SECTION A-A

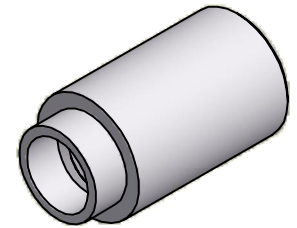

ISO SCALE 3 : 1

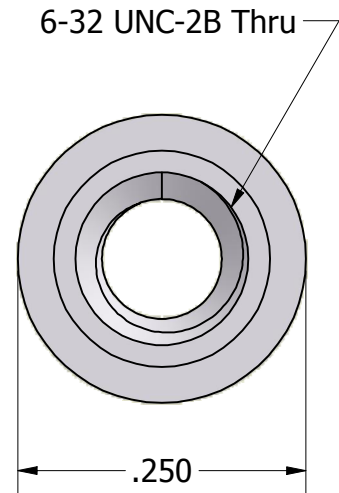
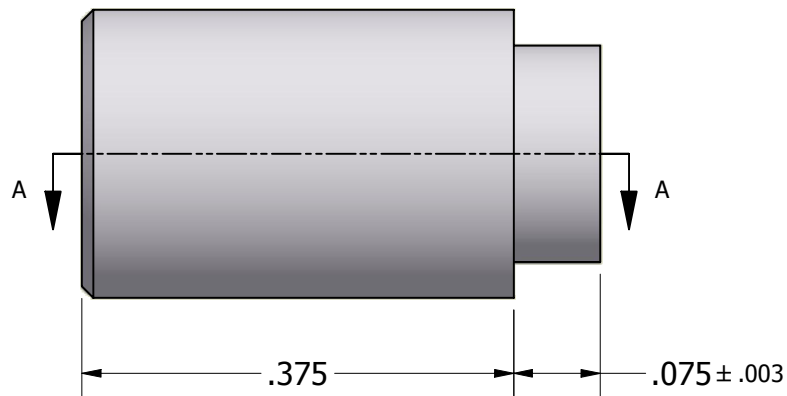

Tolerances Unless Otherwise Specified:

**.xx Decimal:** ± .02  
**.xxx Decimal:** ± .005  
**Fraction:** ± 1/64  
**Angle:** ± 2°

**LYN-TRON, INC.**

Part Number:

**BR6910A-0.375**

Description:

**1/4 Round Swage Standoff**

Drawn By:

**JEFFN**

**06/21/2010**

Gauge:

Material:

**Brass**

Scale:

**6 : 1**