

SECTION A-A

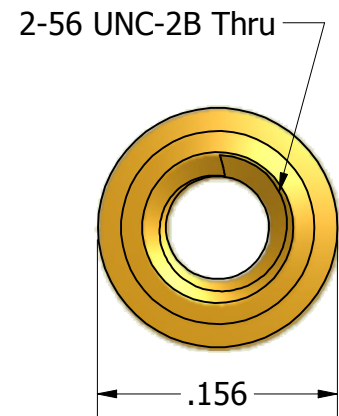

ISO SCALE 4 : 1

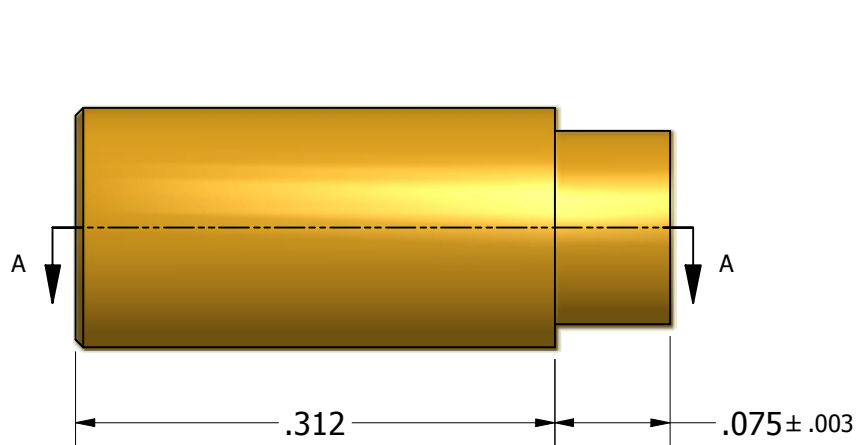

Tolerances Unless Otherwise Specified:

.xx Decimal: ± .02
 .xxx Decimal: ± .005
 Fraction: ± 1/64
 Angle: ± 2°

LYN-TRON, INC.

Part Number:

BR6909A-0.312

Description:

5/32 Round Swage Standoff

Drawn By:

JEFFN

06/17/2010

Gauge:

Material:

Brass

Scale:

8 : 1