

SECTION A-A

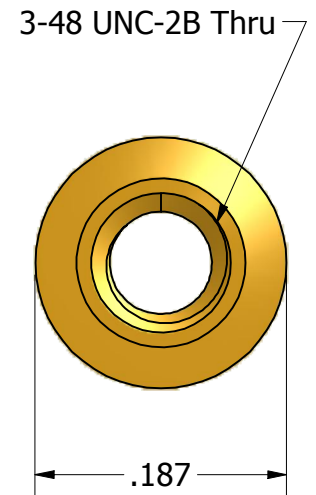

ISO SCALE 3 : 1

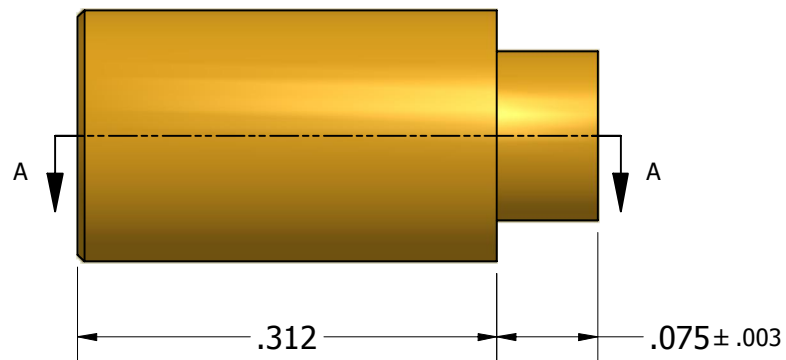

Tolerances Unless Otherwise Specified:

.xx Decimal: $\pm .02$
 .xxx Decimal: $\pm .005$
 Fraction: $\pm 1/64$
 Angle: $\pm 2^\circ$

LYN-TRON, INC.

Part Number:

BR6908A-0.312

Description:

3/16 Round Swage Standoff

Drawn By:

JEFFN

06/17/2010

Gauge:

Material:

Brass

Scale:

7 : 1