

SECTION A-A

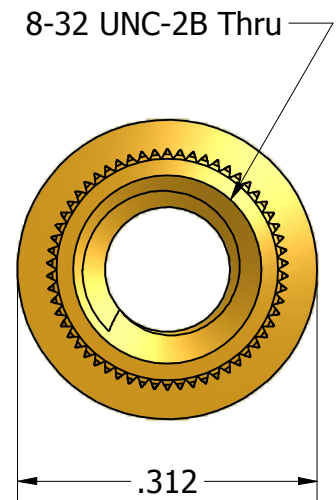

ISO SCALE 2 : 1

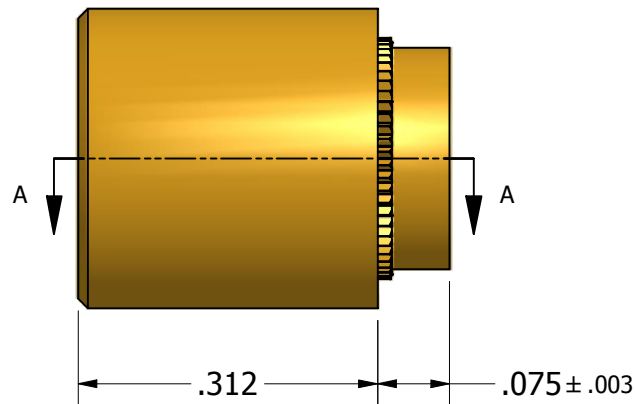

Tolerances Unless Otherwise Specified:

.xx Decimal: ± .02
.xxx Decimal: ± .005
Fraction: ± 1/64
Angle: ± 2°

LYN-TRON, INC.

Part Number:

BR6903SPA-0.312

Description:

5/16" Rnd 8-32 Swage Standoff

Drawn By:

RICKZ 02/29/2012

Gauge:

Material:

Brass

Scale:

5 : 1