

SECTION A-A

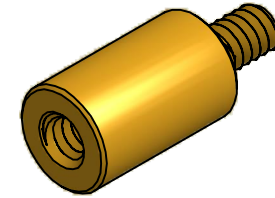

ISO SCALE 2 : 1

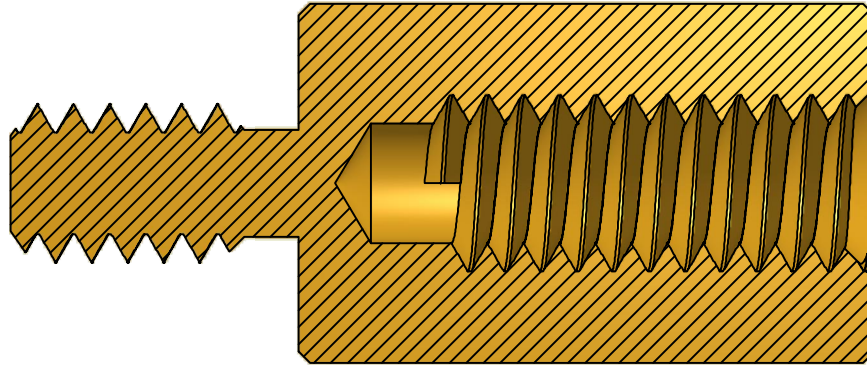
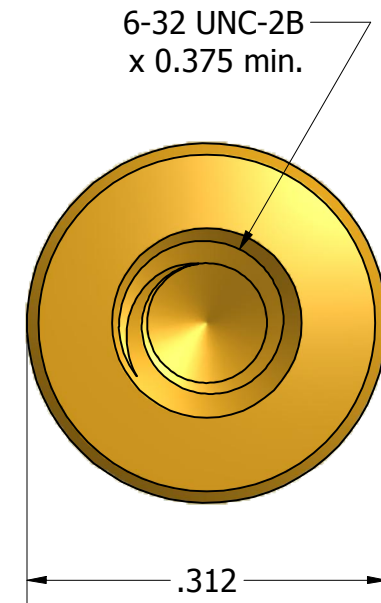
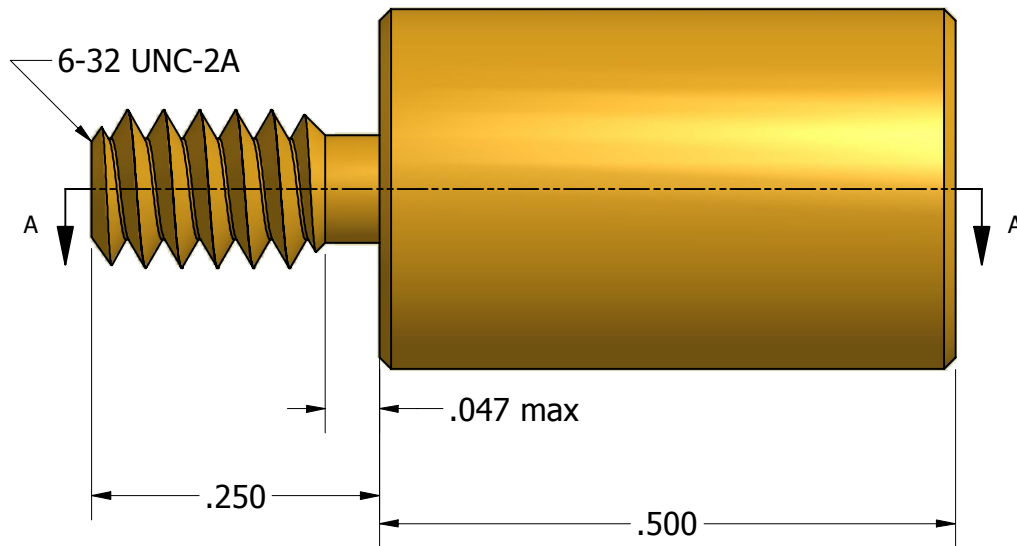

Tolerances Unless Otherwise Specified:

.xx Decimal: ± .02
.xxx Decimal: ± .005
Fraction: ± 1/64
Angle: ± 2°

LYN-TRON, INC.

Part Number:
BR6893-0.500

Description:
5/16 Round Male-Female Standoff

Drawn By:
KENANG 07/07/2011

Gauge:

Material:
Brass

Scale:
6 : 1