

SECTION A-A

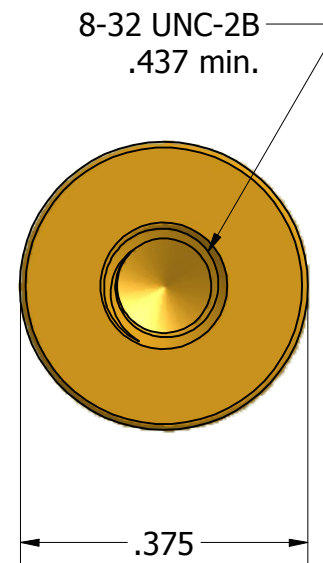
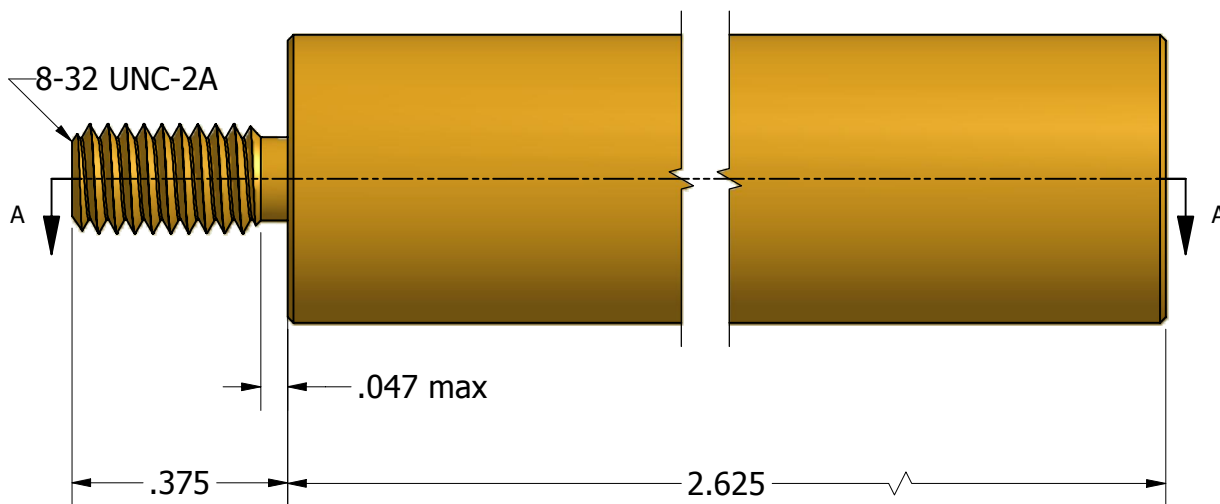
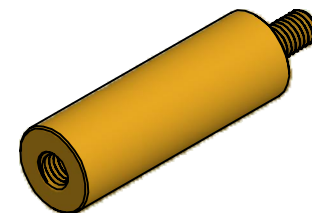
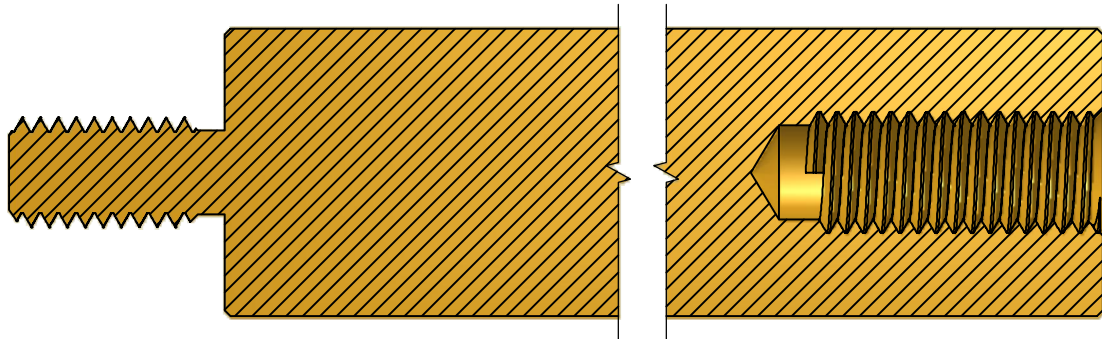

Tolerances Unless Otherwise Specified:

.xx Decimal: $\pm .02$
 .xxx Decimal: $\pm .005$
 Fraction: $\pm 1/64$
 Angle: $\pm 2^\circ$

LYN-TRON, INC.

Part Number:

BR6885-2.625

Description:

3/8 Round Male-Female Standoff

Drawn By:

KENANG 07/07/2011

Gauge:

Material:

Brass

Scale:

NTS