

SECTION A-A

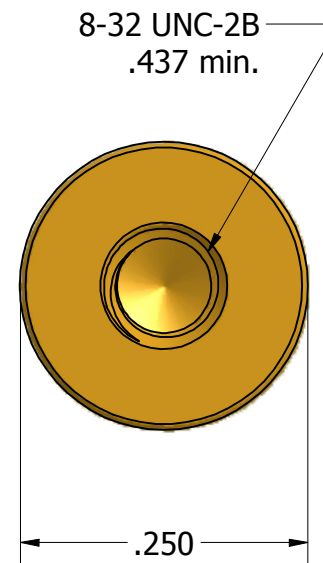
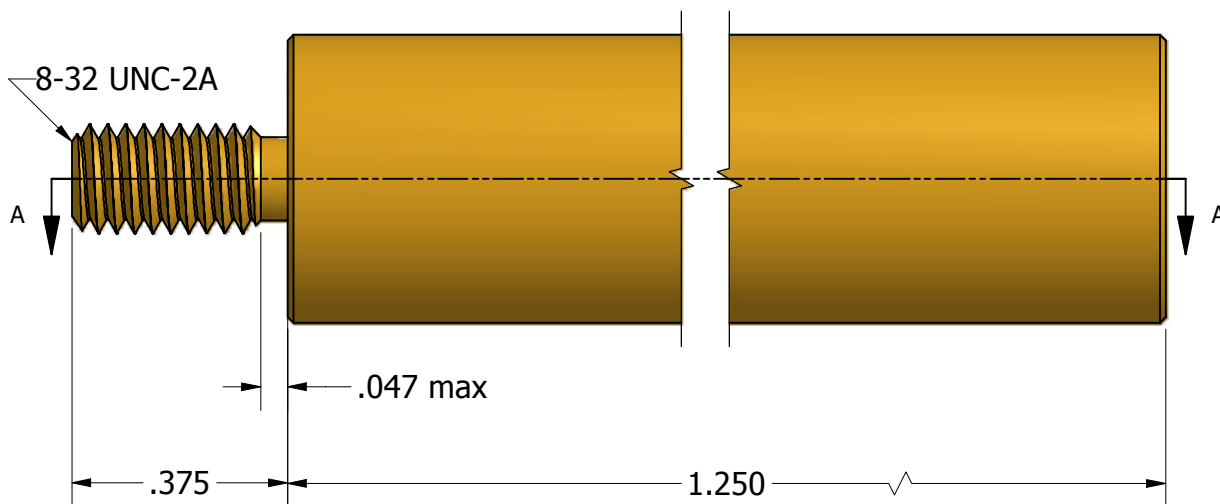
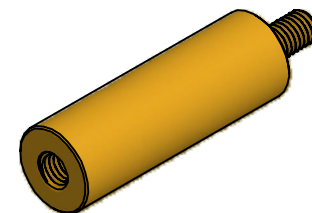
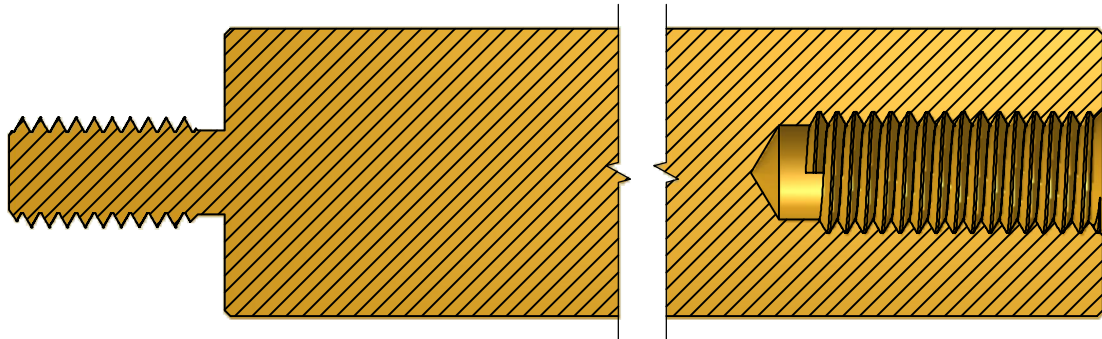

Tolerances Unless Otherwise Specified:

.xx Decimal: $\pm .02$
 .xxx Decimal: $\pm .005$
 Fraction: $\pm 1/64$
 Angle: $\pm 2^\circ$

LYN-TRON, INC.

Part Number:

BR6882-1.250

Description:

1/4 Round Male-Female Standoff

Drawn By:

COURTNEYS07/05/2011

Gauge:

Material:

Brass

Scale:

NTS