

SECTION A-A

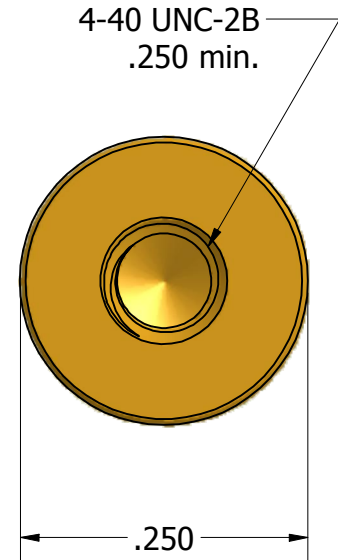
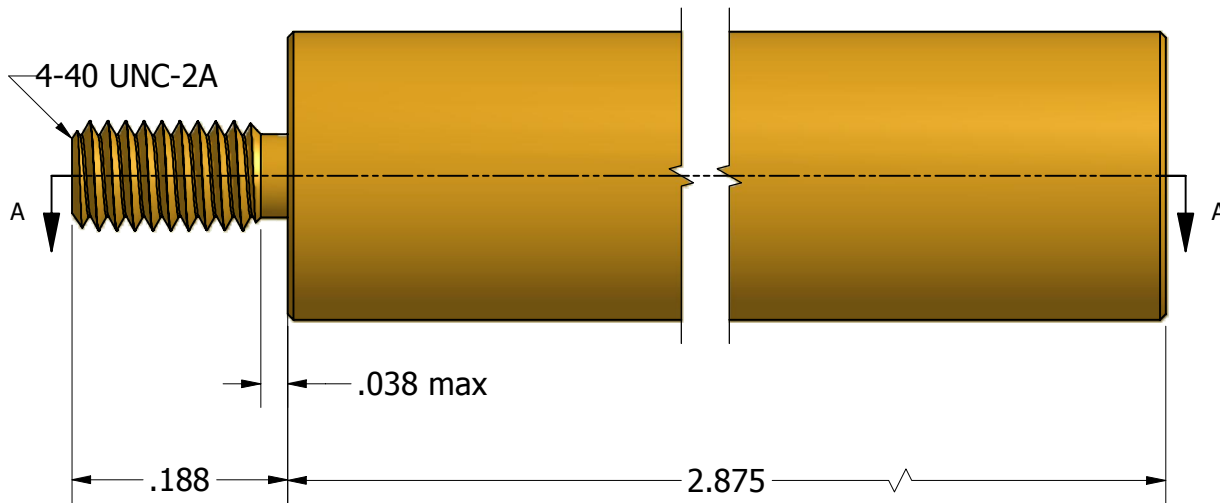
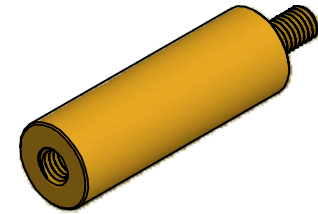
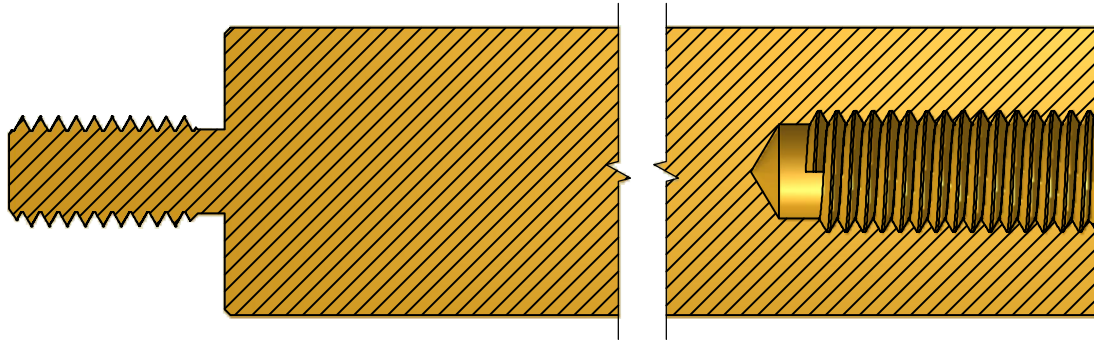

Tolerances Unless Otherwise Specified:

.xx Decimal: ± .02
.xxx Decimal: ± .005
Fraction: ± 1/64
Angle: ± 2°

LYN-TRON, INC.

Part Number:

BR6880-2.875

Description:

1/4 Round Male-Female Standoff

Drawn By:

COURTNEYS07/05/2011

Gauge:

Material:

Brass

Scale:

NTS