

SECTION A-A

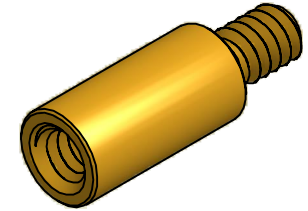

ISO SCALE 3 : 1

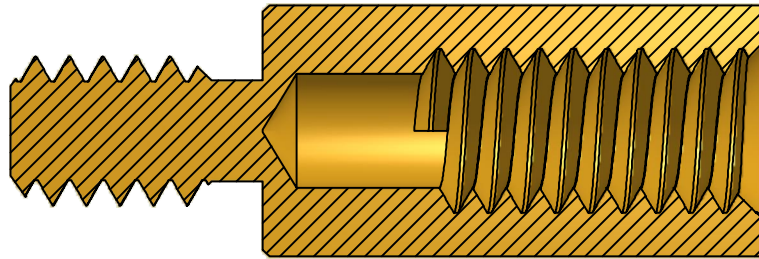
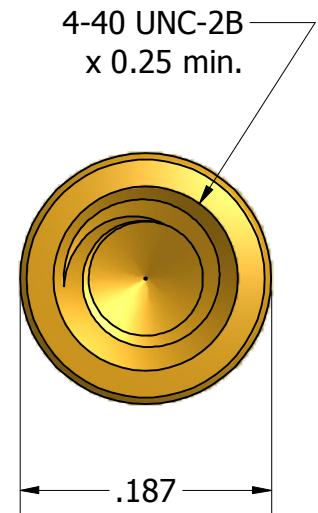
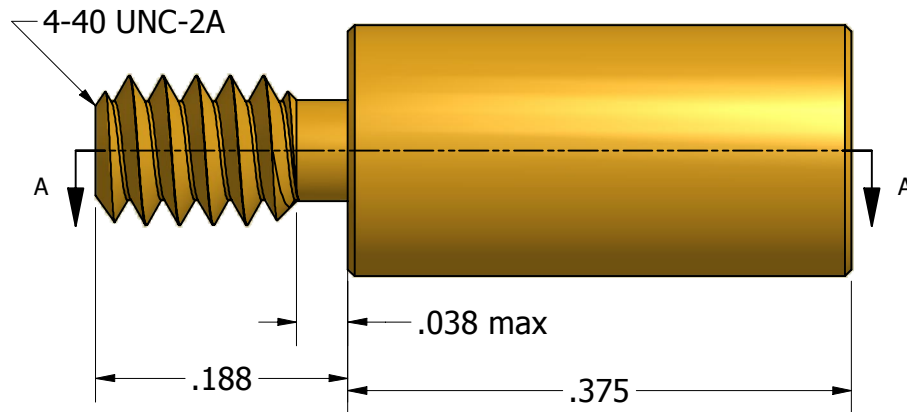

Tolerances Unless Otherwise Specified:

.xx Decimal: ± .02
.xxx Decimal: ± .005
Fraction: ± 1/64
Angle: ± 2°

LYN-TRON, INC.

Part Number:

BR6879-0.375

Description:

3/16 Round Male-Female Standoff

Drawn By:

COURTNEYS06/24/2011

Gauge:

Material:

Brass

Scale:

7 : 1