

SECTION A-A

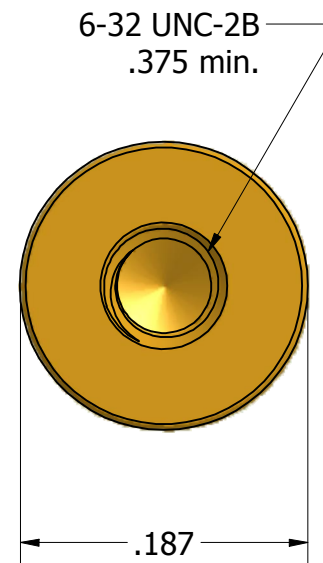
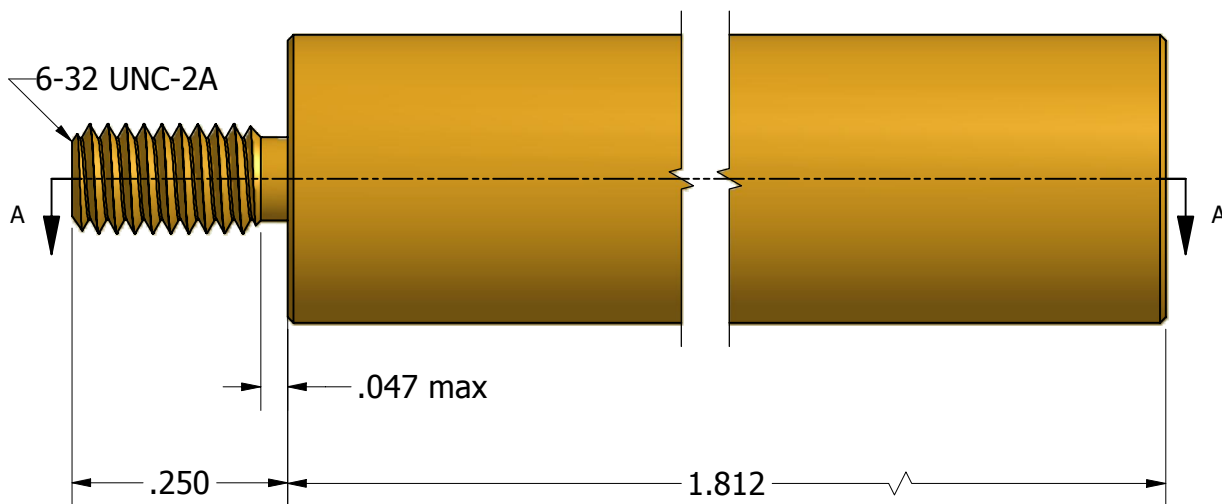
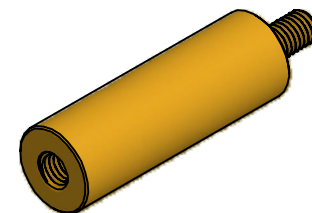
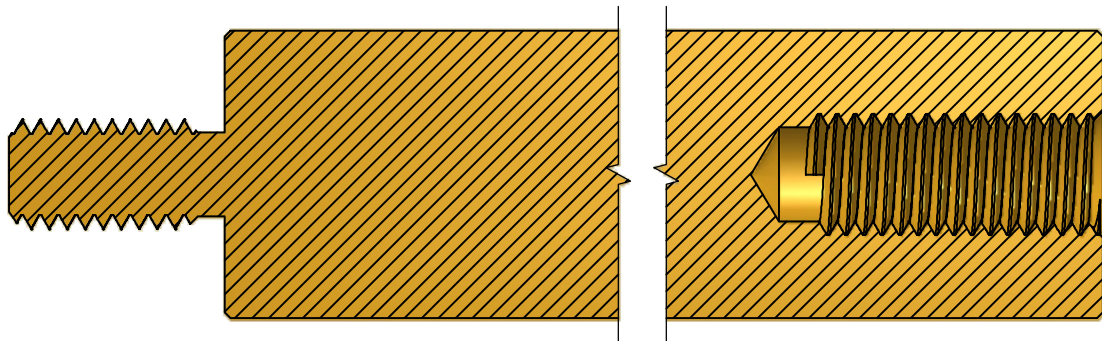

Tolerances Unless Otherwise Specified:

.xx Decimal:  $\pm .02$   
 .xxx Decimal:  $\pm .005$   
 Fraction:  $\pm 1/64$   
 Angle:  $\pm 2^\circ$

**LYN-TRON, INC.**

Part Number:

**BR6877-1.812**

Description:

**3/16 Round Male-Female Standoff**

Drawn By:

**COURTNEYS06/24/2011**

Gauge:

Material:

**Brass**

Scale:

**NTS**