

SECTION A-A

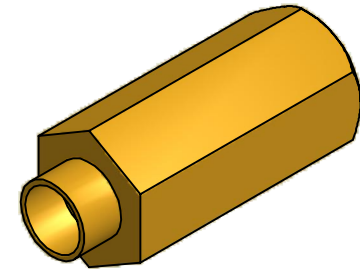

ISO SCALE 2 : 1

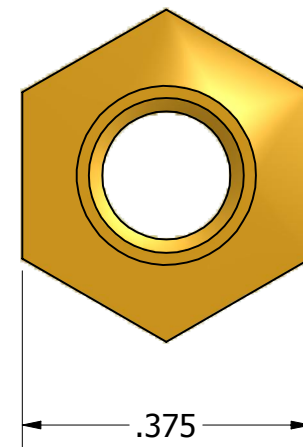
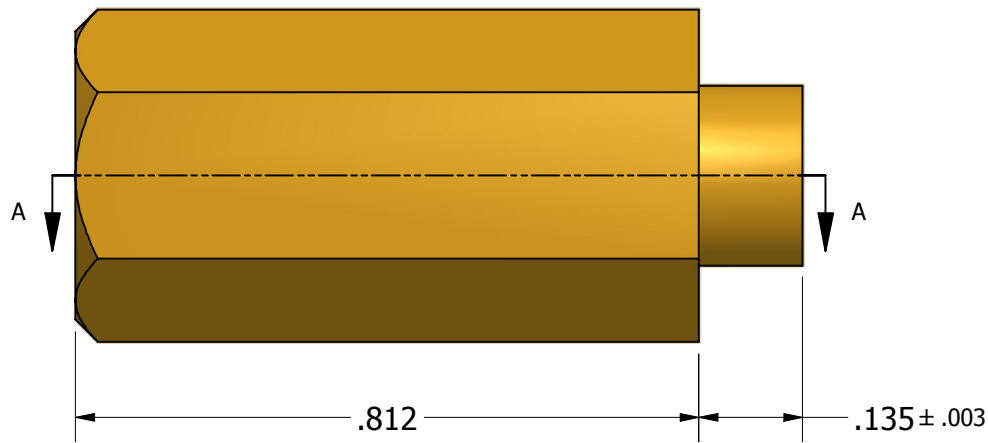

Tolerances Unless Otherwise Specified:

.xx Decimal: $\pm .02$
 .xxx Decimal: $\pm .005$
 Fraction: $\pm 1/64$
 Angle: $\pm 2^\circ$

LYN-TRON, INC.

Part Number:

BR6334C-0.812

Description:

3/8 Hex Swage Spacer

Drawn By:

COURTNEYS04/27/2011

Gauge:

Material:

Brass

Scale:

4 : 1