

SECTION A-A

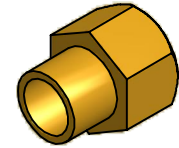

ISO SCALE 3 : 1

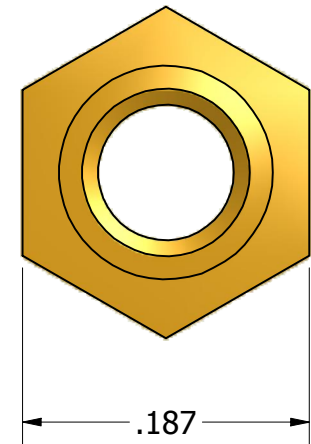
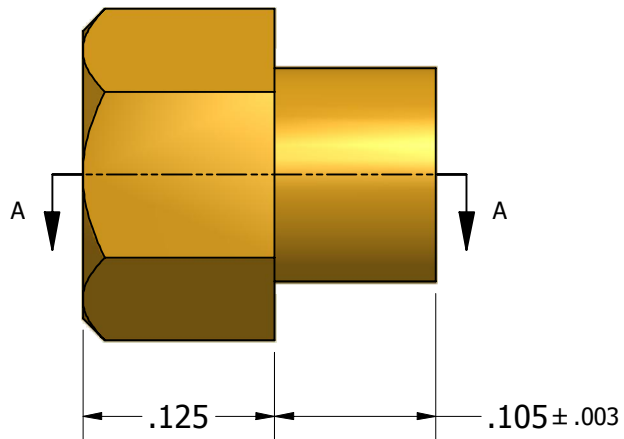

Tolerances Unless Otherwise Specified:

**.xx Decimal:**  $\pm .02$   
**.xxx Decimal:**  $\pm .005$   
**Fraction:**  $\pm 1/64$   
**Angle:**  $\pm 2^\circ$

**LYN-TRON, INC.**

Part Number:

**BR6324B-0.125**

Description:

**3/16 Hex Swage Spacer**

Drawn By:

**COURTNEYS04/27/2011**

Gauge:

Material:

**Brass**

Scale:

**8 : 1**