

SECTION A-A

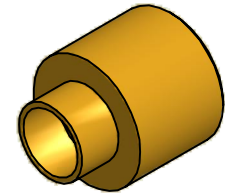

ISO SCALE 2 : 1

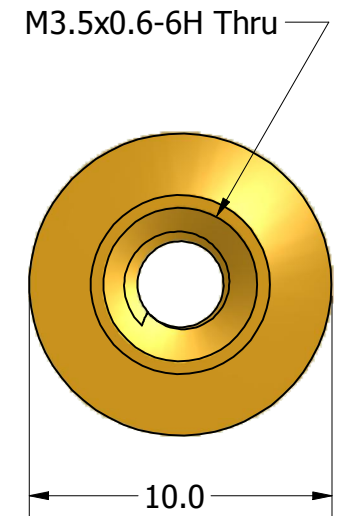
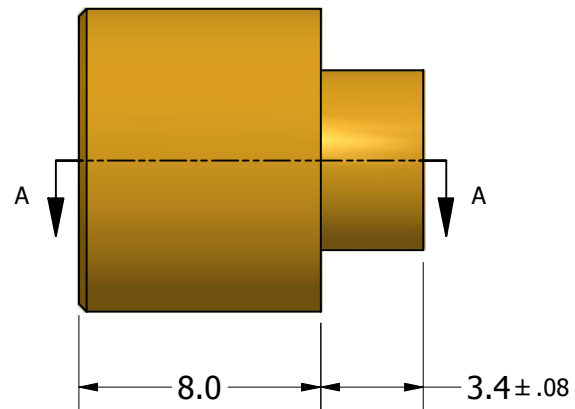

Tolerances Unless Otherwise Specified:

.x Decimal: ± 0.3
 .xx Decimal: $\pm .13$
 Fraction: $\pm 1/64$
 Angle: $\pm 2^\circ$

LYN-TRON, INC.

Part Number:

BR5121C-08.0

Description:

10mm Rnd M3.5X.6 Swage Standoff

Drawn By:

RICKZ 03/14/2012

Gauge:

Material:

Brass

Scale:

4 : 1