

SECTION A-A

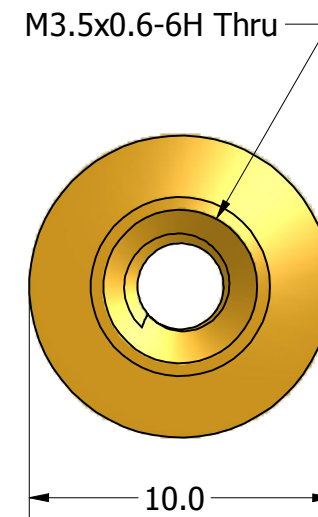

ISO SCALE 2 : 1

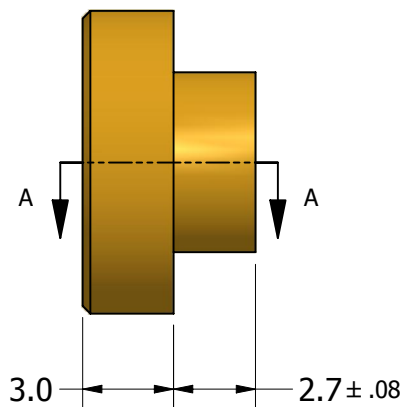

Tolerances Unless Otherwise Specified:

.x Decimal: ± 0.3  
 .xx Decimal: ± .13  
 Fraction: ± 1/64  
 Angle: ± 2°

**LYN-TRON, INC.**

Part Number:

**BR5121B-03.0**

Description:

**10mm Rnd M3.5X.6 Swage Standoff**

Drawn By:

**RICKZ 03/13/2012**

Gauge:

Material:

**Brass**

Scale:

**4 : 1**