

SECTION A-A

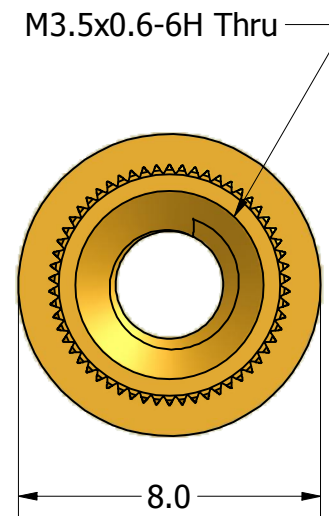

ISO SCALE 2 : 1

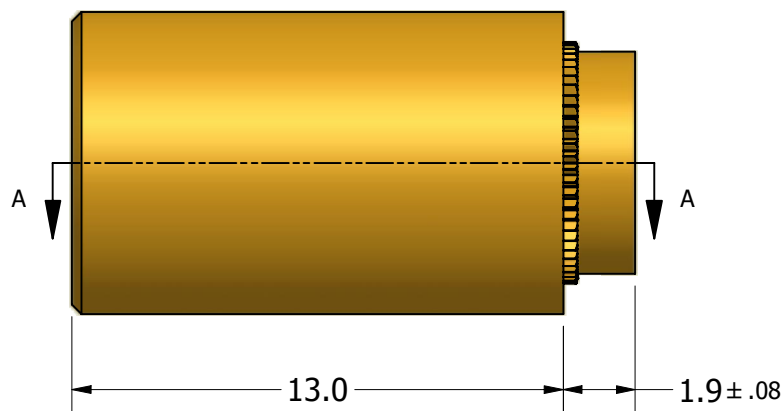

Tolerances Unless Otherwise Specified:

.x Decimal: ± 0.3
 .xx Decimal: ± .13
 Fraction: ± 1/64
 Angle: ± 2°

LYN-TRON, INC.

Part Number:

BR5117SPA-13.0

Description:

8mm Rnd M3.5X.6 Swage Standoff

Drawn By:

COURTNEYS08/02/2012

Gauge:

Material:

Brass

Scale:

5 : 1