

SECTION A-A

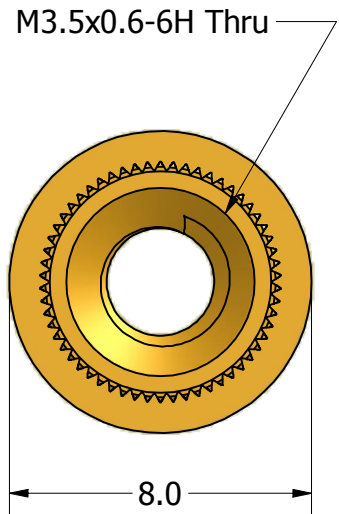

ISO SCALE 2 : 1

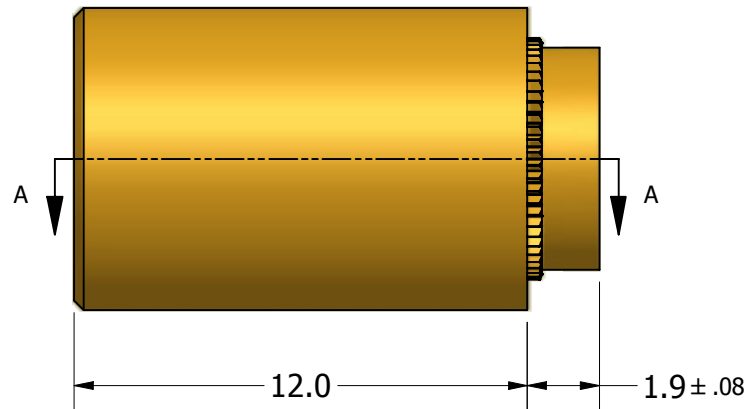

Tolerances Unless Otherwise Specified:
 .x Decimal: ± 0.3
 .xx Decimal: ± .13
 Fraction: ± 1/64
 Angle: ± 2°

LYN-TRON, INC.

Part Number:
BR5117SPA-12.0

Description:
8mm Rnd M3.5X.6 Swage Standoff

Drawn By:
COURTNEYS08/02/2012

Gauge:

Material:
Brass

Scale:
5 : 1