

SECTION A-A

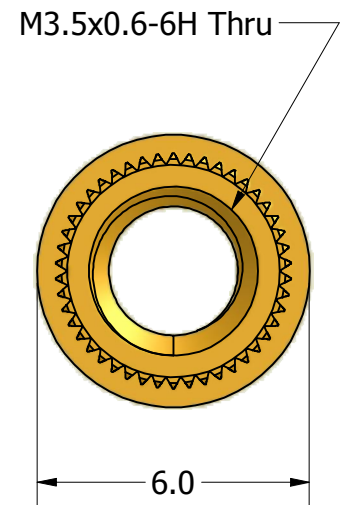

ISO SCALE 3 : 1

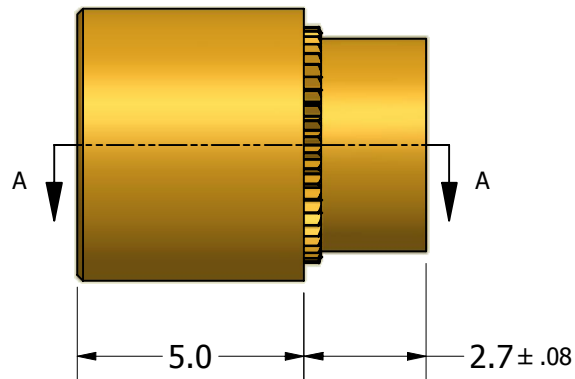

Tolerances Unless Otherwise Specified:

.x Decimal: ± 0.3
 .xx Decimal: ± .13
 Fraction: ± 1/64
 Angle: ± 2°

LYN-TRON, INC.

Part Number:

BR5115SPB-05.0

Description:

6mm Rnd M3.5X.6 Swage Standoff

Drawn By:

COURTNEYS07/31/2012

Gauge:

Material:

Brass

Scale:

6 : 1