

SECTION A-A

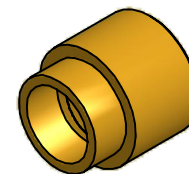

ISO SCALE 3 : 1

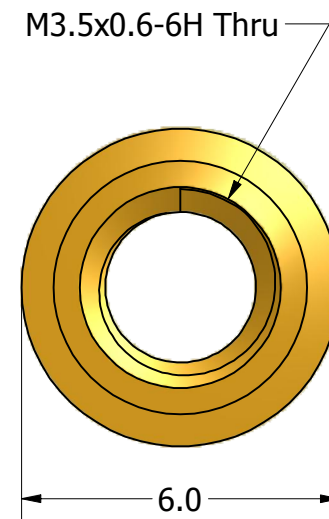
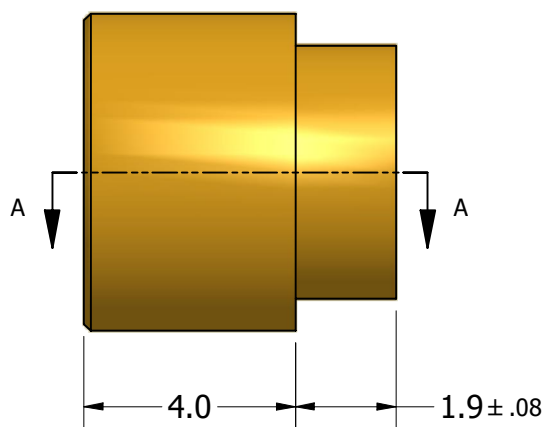

Tolerances Unless Otherwise Specified:

.x Decimal: ± 0.3  
 .xx Decimal: ± .13  
 Fraction: ± 1/64  
 Angle: ± 2°

**LYN-TRON, INC.**

Part Number:

**BR5115A-04.0**

Description:

**6mm Rnd M3.5X.6 Swage Standoff**

Drawn By:

**RICKZ 03/06/2012**

Gauge:

Material:

**Brass**

Scale:

**7 : 1**