

SECTION A-A

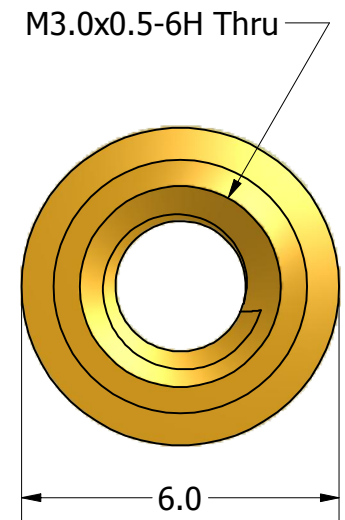

ISO SCALE 3 : 1

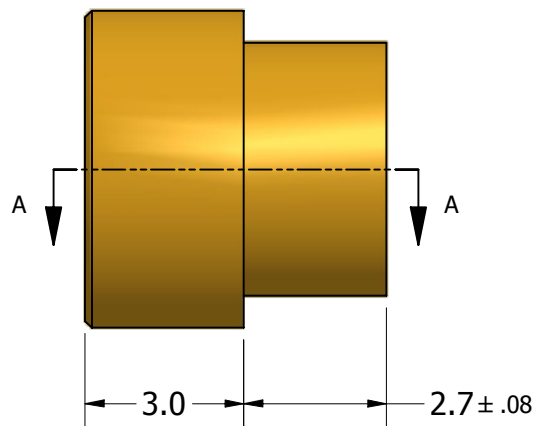

Tolerances Unless Otherwise Specified:

.x Decimal: ± 0.3
 .xx Decimal: ± .13
 Fraction: ± 1/64
 Angle: ± 2°

LYN-TRON, INC.

Part Number:

BR5114B-03.0

Description:

6mm Rnd M3X.5 Swage Standoff

Drawn By:

RICKZ 03/05/2012

Gauge:

Material:

Brass

Scale:

7 : 1