

SECTION A-A

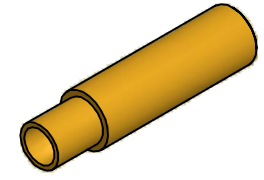

ISO SCALE 2 : 1

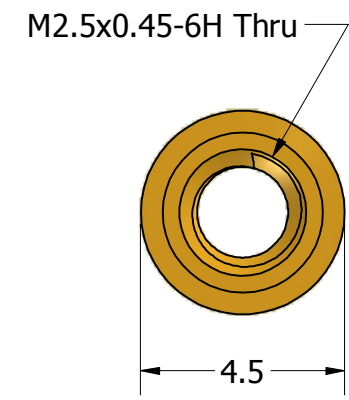
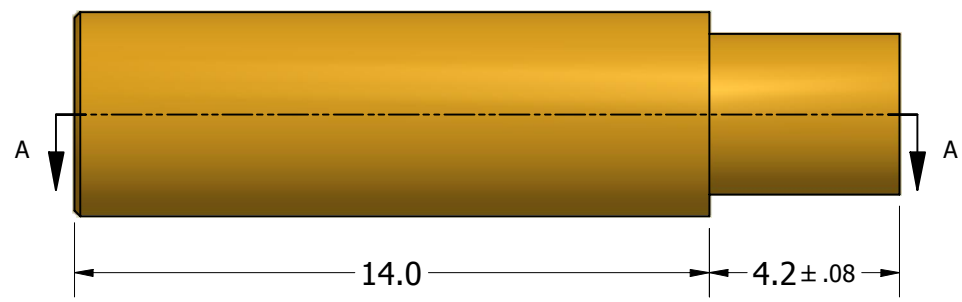

Tolerances Unless Otherwise Specified:
.x Decimal: ± 0.3
.xx Decimal: ± .13
Fraction: ± 1/64
Angle: ± 2°

LYN-TRON, INC.

Part Number:
BR5107D-14.0

Description:
4.5mm Rnd M2.5X.45 Swage Standoff

Drawn By:
RICKZ 03/05/2012

Gauge:

Material:
Brass

Scale:
6 : 1