

SECTION A-A

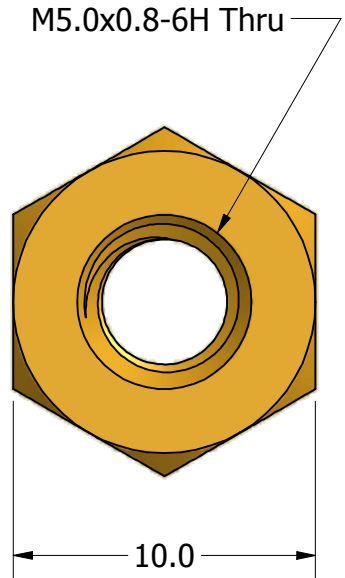

ISO SCALE 1 : 1

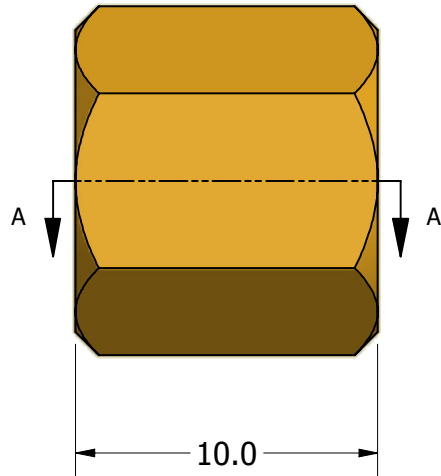

Tolerances Unless Otherwise Specified:

.x Decimal: ± 0.3
 .xx Decimal: $\pm .13$
 Fraction: $\pm 1/64$
 Angle: $\pm 2^\circ$

LYN-TRON, INC.

Part Number:

BR5086-5080-10.0

Description:

10mm Hex Standoff

Drawn By:

COURTNEYS08/14/2012

Gauge:

Material:

Brass

Scale:

4 : 1