

SECTION A-A

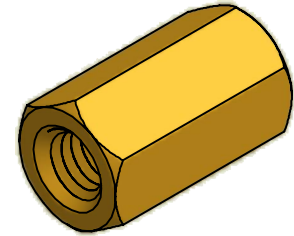

ISO SCALE 3 : 1

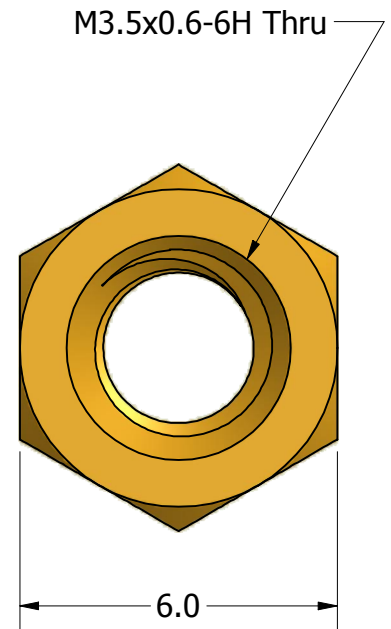
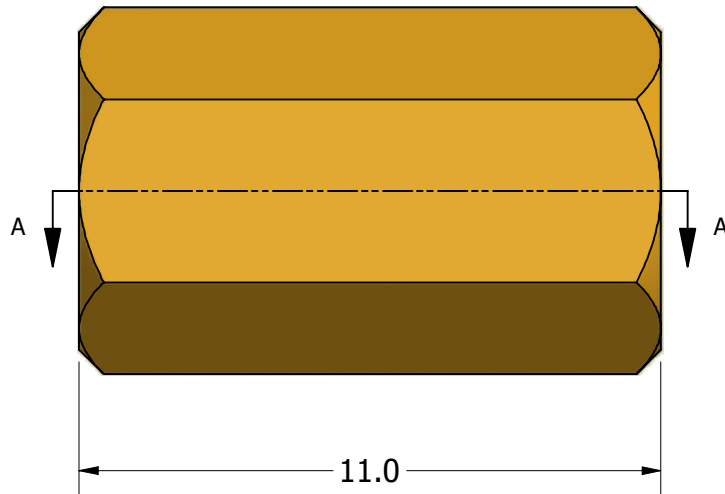

Tolerances Unless Otherwise Specified:

- .x Decimal:** ± 0.3
- .xx Decimal:** ± .13
- Fraction:** ± 1/64
- Angle:** ± 2°

LYN-TRON, INC.

Part Number:

BR5083-3560-11.0

Description:

6mm Hex Standoff

Drawn By:

COURTNEYS08/07/2012

Gauge:

Material:

Brass

Scale:

7 : 1