

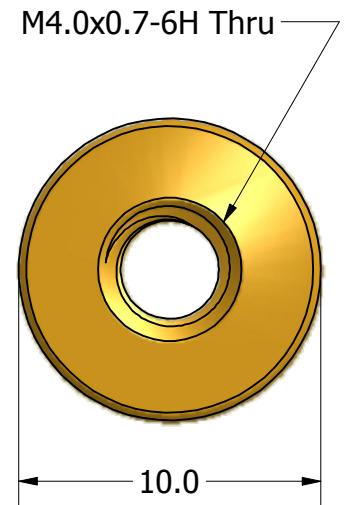

SECTION A-A

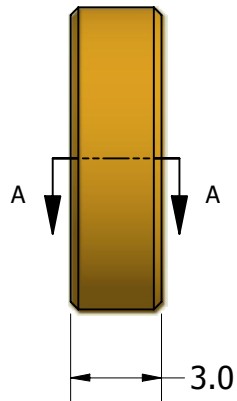

ISO SCALE 1 : 1



Tolerances Unless Otherwise Specified:			
.x Decimal:	± 0.3		
.xx Decimal:	± .13	Part Number:	
Fraction:	± 1/64	BR5074-4070-03.0	
Angle:	± 2°	Description:	
		10mm Rnd Standoff	
Drawn By:	Gauge:	Material:	Scale:
JEFFN	06/20/2010	Brass	4 : 1