

SECTION A-A

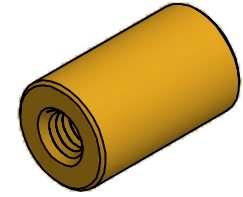

ISO SCALE 2 : 1

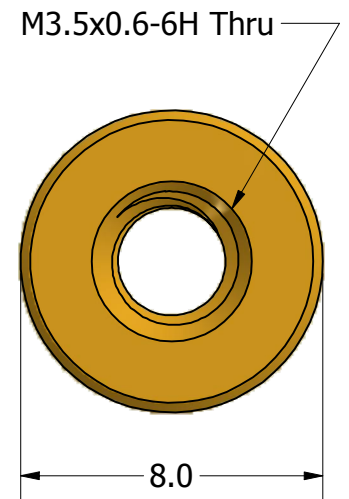
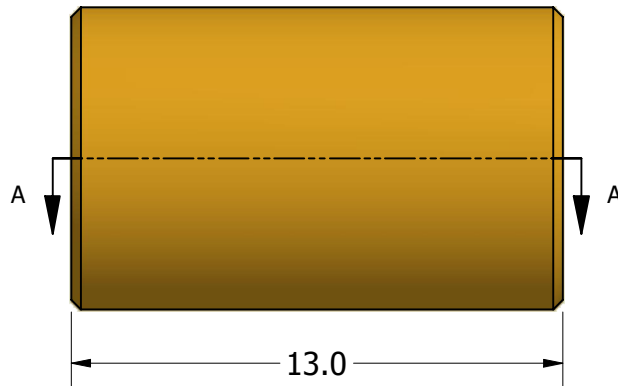

Tolerances Unless Otherwise Specified:

- .x Decimal:** ± 0.3
- .xx Decimal:** ± .13
- Fraction:** ± 1/64
- Angle:** ± 2°

LYN-TRON, INC.

Part Number:
BR5073-3560-13.0

Description:
8mm Rnd Standoff

Drawn By:
JEFFN 06/20/2010

Gauge:

Material:
Brass

Scale:
5 : 1