

SECTION A-A

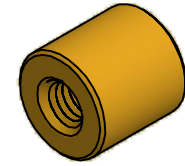

ISO SCALE 2 : 1

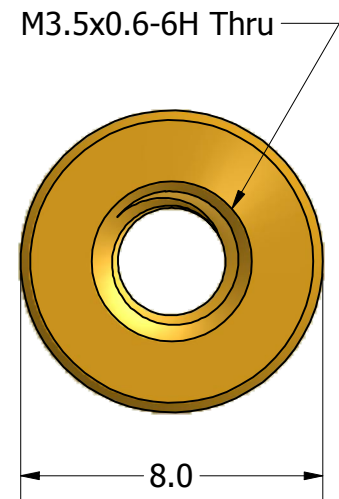
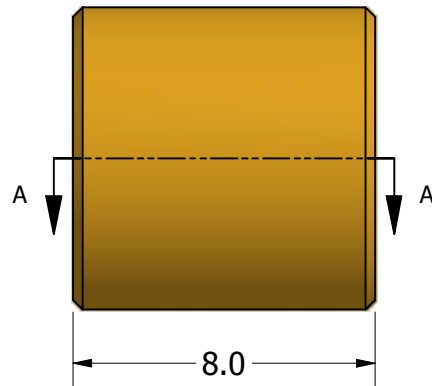

Tolerances Unless Otherwise Specified:

**.x Decimal:** ± 0.3  
**.xx Decimal:** ± .13  
**Fraction:** ± 1/64  
**Angle:** ± 2°

**LYN-TRON, INC.**

Part Number:  
**BR5073-3560-08.0**

Description:  
**8mm Rnd Standoff**

Drawn By:  
**JEFFN 06/20/2010**

Gauge:

Material:  
**Brass**

Scale:  
**5 : 1**