

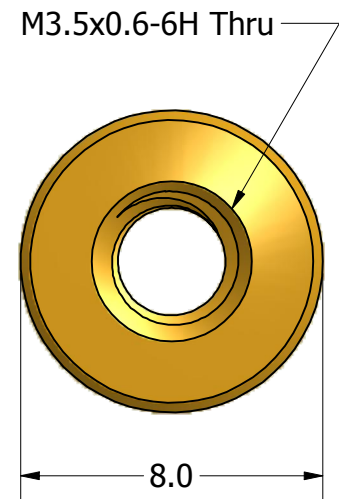

SECTION A-A

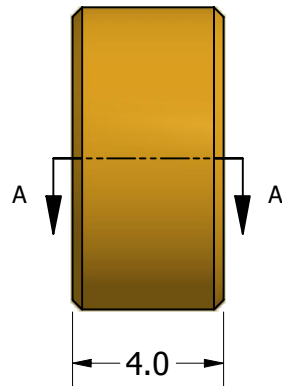

ISO SCALE 2 : 1



Tolerances Unless Otherwise Specified:

.x Decimal: ± 0.3
.xx Decimal: ± .13
Fraction: ± 1/64
Angle: ± 2°

LYN-TRON, INC.

Part Number:

BR5073-3560-04.0

Description:

8mm Rnd Standoff

Drawn By:

JEFFN

06/20/2010

Gauge:

Material:

Brass

Scale:

5 : 1