

SECTION A-A

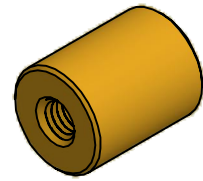

ISO SCALE 2 : 1

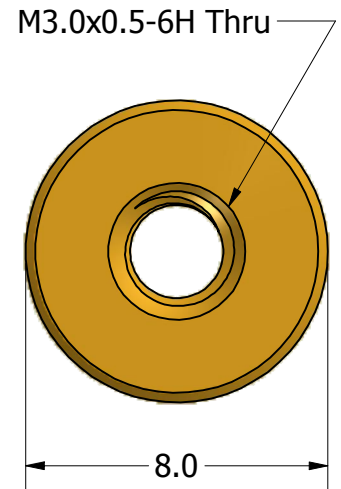
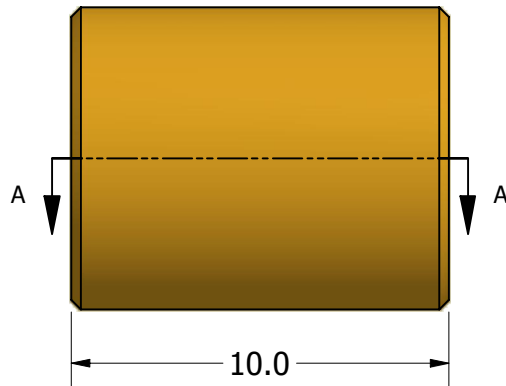

Tolerances Unless Otherwise Specified:

.x Decimal: ± 0.3
.xx Decimal: ± .13
Fraction: ± 1/64
Angle: ± 2°

LYN-TRON, INC.

Part Number:
BR5073-3050-10.0

Description:
8mm Rnd Standoff

Drawn By:
JEFFN 06/20/2010

Gauge:

Material:
Brass

Scale:
5 : 1