

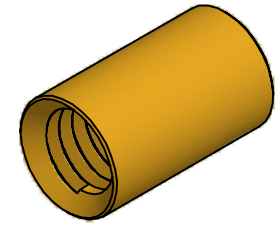

SECTION A-A

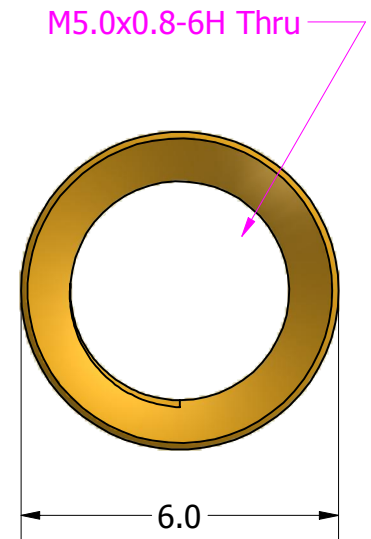

ISO SCALE 3 : 1

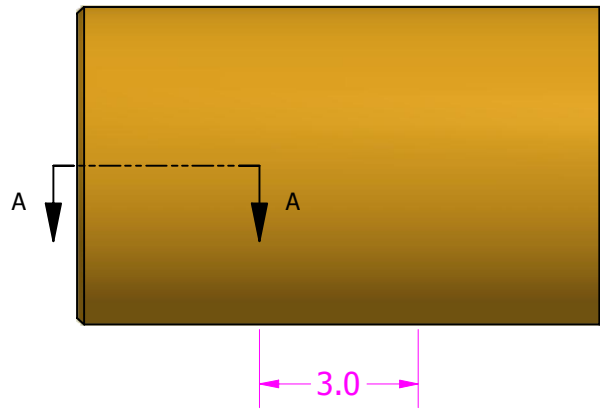

Tolerances Unless Otherwise Specified:

.x Decimal: ± 0.3
 .xx Decimal: $\pm .13$
 Fraction: $\pm 1/64$
 Angle: $\pm 2^\circ$

LYN-TRON, INC.

Part Number:
BR5071-5080-10.0

Description:
6mm Rnd Standoff

Drawn By:
JEFFN 06/20/2010

Gauge:

Material:
Brass

Scale:
7 : 1