

SECTION A-A

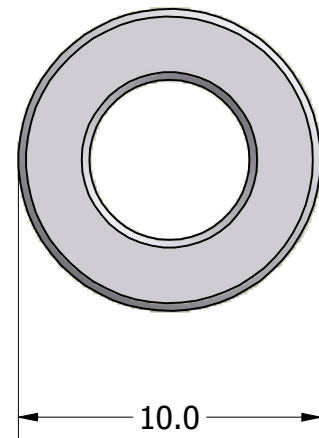

ISO SCALE 2 : 1

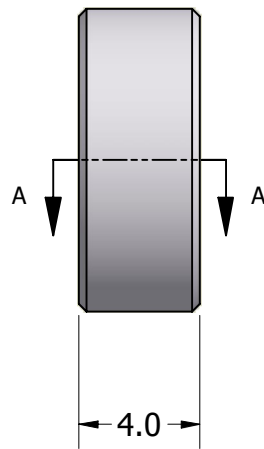

Tolerances Unless Otherwise Specified:

**.x Decimal:** ± 0.3  
**.xx Decimal:** ± .13  
**Fraction:** ± 1/64  
**Angle:** ± 2°

**LYN-TRON, INC.**

Part Number:

**BR5008-50-04.0**

Description:

**10mm Rnd Spacer**

Drawn By:

**JEFFN**

**06/20/2010**

Gauge:

Material:

**Brass**

Scale:

**4 : 1**