

SECTION A-A

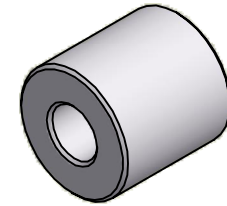

ISO SCALE 2 : 1

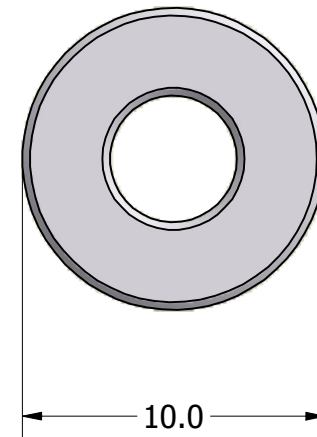
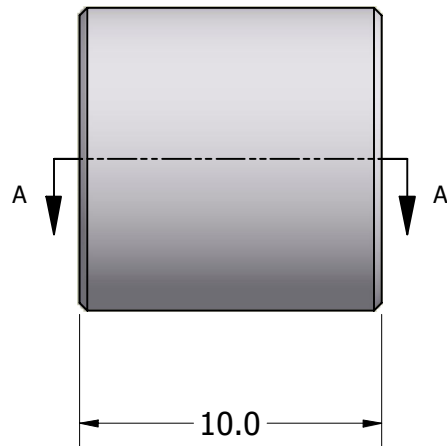

Tolerances Unless Otherwise Specified:

.x Decimal: ± 0.3  
 .xx Decimal: ± .13  
 Fraction: ± 1/64  
 Angle: ± 2°

**LYN-TRON, INC.**

Part Number:

**BR5008-40-10.0**

Description:

**10mm Rnd Spacer**

Drawn By:

**JEFFN**

**06/20/2010**

Gauge:

Material:

**Brass**

Scale:

**4 : 1**