

SECTION A-A

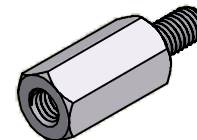

ISO SCALE 1 : 1

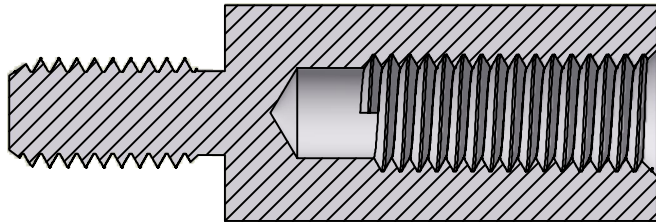
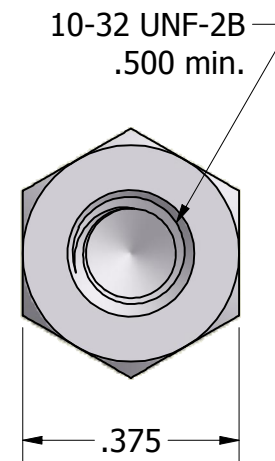
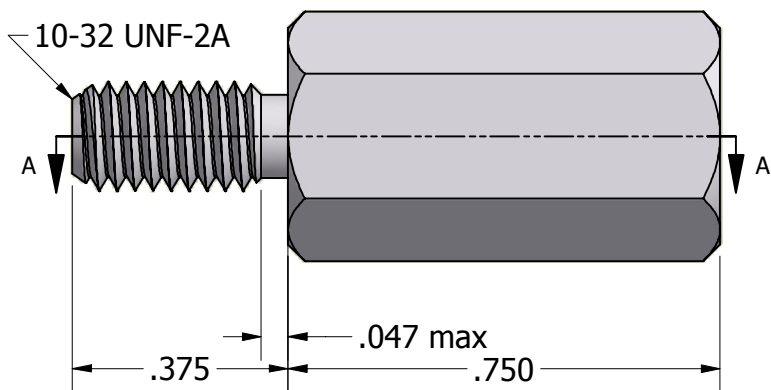

Tolerances Unless Otherwise Specified:

**.xx Decimal:** ± .02  
**.xxx Decimal:** ± .005  
**Fraction:** ± 1/64  
**Angle:** ± 2°

**LYN-TRON, INC.**

Part Number:  
**AA6986-0.750**

Description:  
**3/8 Hex Male-Female Standoff**

Drawn By:  
**KENANG 06/24/2011**

Gauge:

Material:  
**Aluminum (RoHS)**

Scale:  
**3 : 1**