

SECTION A-A

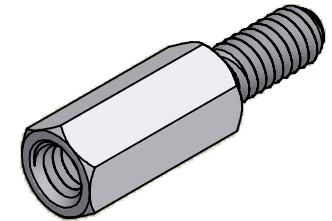

ISO SCALE 2 : 1

8-32 UNC-2B
x 0.437 min.

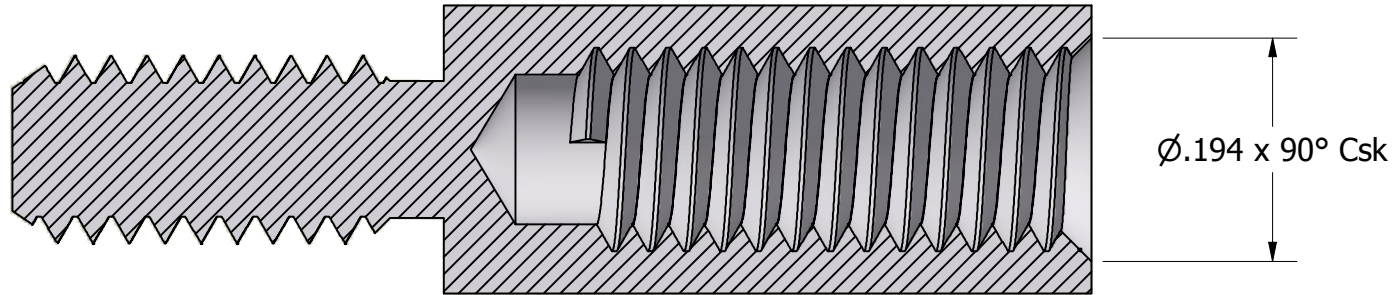
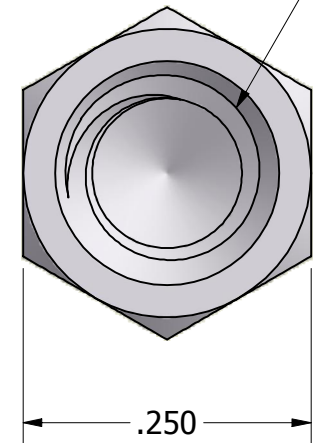
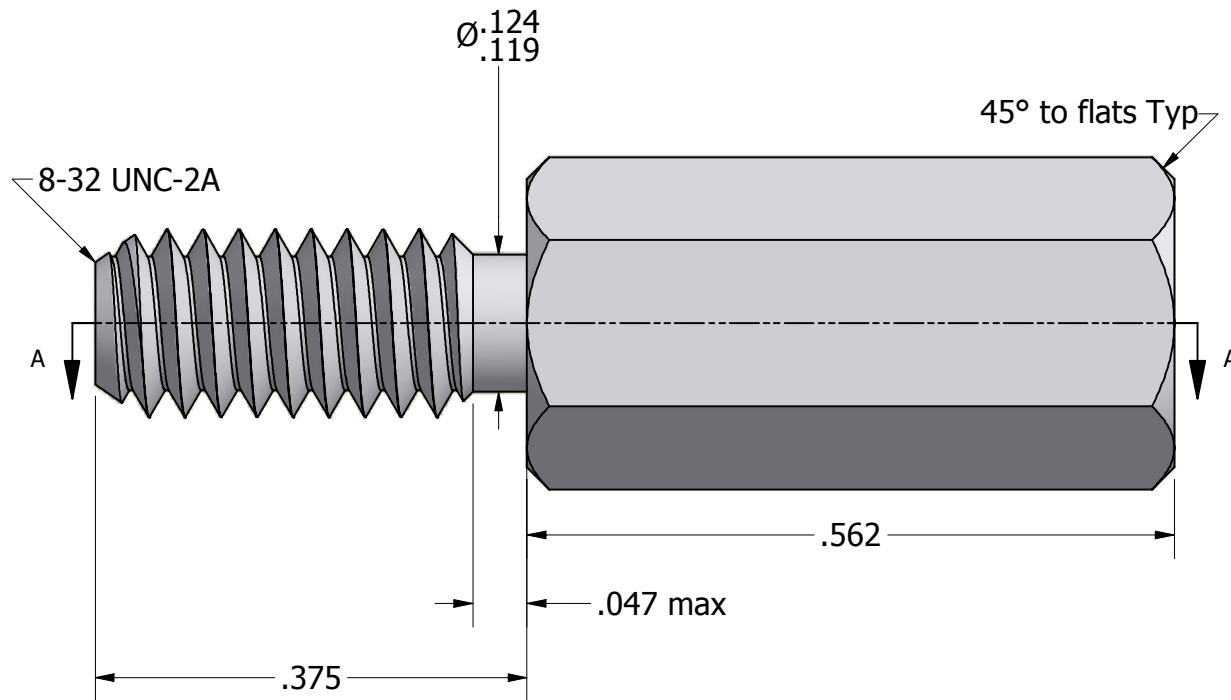

Tolerances Unless Otherwise Specified:

.xx Decimal: ± .02
.xxx Decimal: ± .005
Fraction: ± 1/64
Angle: ± 2°

LYN-TRON, INC.

Part Number:

AA6982-0.562

Description:

1/4 Hex Male-Female Standoff

Drawn By:

KENANG 06/24/2011

Gauge:

Material:

Aluminum (RoHS)

Scale:

6 : 1