

SECTION A-A

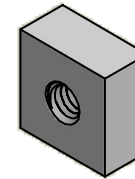

ISO SCALE 1 : 1

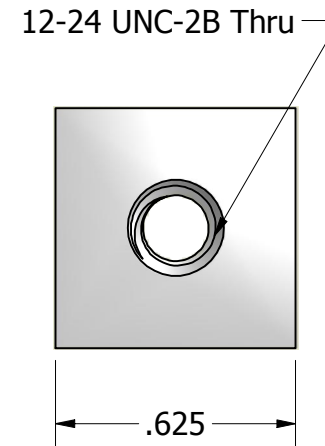
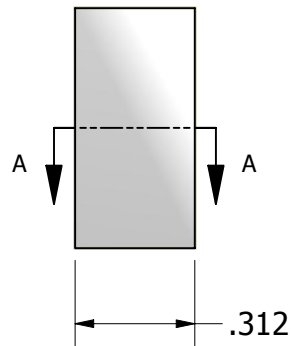

Tolerances Unless Otherwise Specified:

.xx Decimal: ± .02
.xxx Decimal: ± .005
Fraction: ± 1/64
Angle: ± 2°

LYN-TRON, INC.

Part Number:

AA6966-1224-0.312

Description:

5/8 Square Standoff

Drawn By:

JEFFN

06/29/2010

Gauge:

Material:

Aluminum (RoHS)

Scale:

2 : 1